

Chloraloy®

Shower Pan Liner

A waterproofing membrane used under a full mortar bed installation of ceramic tile, dimension stone or terrazzo tile.



- **Made from Chlorinated Polyethylene (CPE)**
 - Will not rot, crack or rust
 - 40 years of proven performance
- **Absolute waterproofing**
 - Water vapor transmission rate of .07 perms (ASTM E 96, Procedure A)
- **Saves Time - No curing**
 - Flood test in minutes
- **The Industry Standard**
 - Meets IPC and UPC requirements
- **Warranted for life**

Installation:*



1. Install Chloraloy allowing for upturns - exact measurements not required.



2. Fold corners and fasten upturns to studs.

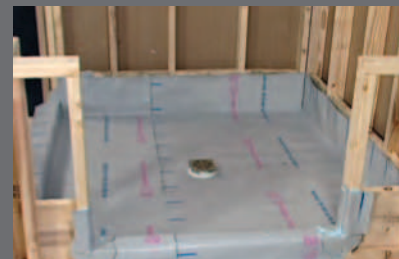

3. Completed in minutes.

* CAUTION: Read complete installation instructions prior to installing.

Chloraloy Product Description

APPLICATIONS

Shower pans, Roman tub liners, steam rooms, toilet rooms, hydrotherapy rooms, reflecting pools, fountains and planters.

HOW TO SPECIFY

Specify in Division 9 or Division 15 • Where required, provide Chloraloy, a sheet membrane manufactured from Chlorinated Polyethylene (CPE), with a nominal thickness of 1.0mm (.040"). Sheet shall meet the requirements of ASTM D 4068, IPC, and IAPMO (UPC File #3046).

COMPOSITION & MATERIALS

Chloraloy is manufactured from CPE, a non-plasticized elastomer.

PRODUCT DIMENSIONS

- 1.2m x 15.2m = 18.6m² (4' x 50' = 200 sq. ft.)
- 1.5m x 12.2m = 18.6m² (5' x 40' = 200 sq. ft.)
- 1.8m x 10.1m = 18.6m² (6' x 33-1/3' = 200 sq. ft.)
- Nominal thickness is 1.0mm (.040").

LIMITATIONS: Tile cannot be bonded directly to Chloraloy. A mortar bed should be installed over Chloraloy. Chloraloy is not designed for prolonged exposure to direct sunlight.

NOTE: Chloraloy must be installed in compliance with local building codes, appropriate ANSI Standards, and TCNA recommendations. See installation instructions for more details. Contact Noble Company for other information.

WARRANTY

Chloraloy brand CPE membrane is guaranteed for the life of the original installation by Noble Company against failure caused by rotting, cracking and microorganism deterioration when properly installed in concealed construction waterproofing and applications for which its use is recommended by Noble Company. This warranty is limited to the replacement of defective material and freight charges to destination only. There are no other expressed or implied warranties, and this warranty is in lieu of any other warranty, including, but not limited to, implied warranties of merchantability and fitness for purpose. Noble Company is not responsible for consequential damages. The remedy of the purchaser set forth herein is exclusive.

TEST DATA - Based on 40 Mil Unsupported Sheet

PROPERTY	TEST METHOD	UNITS	SPECIFICATION	TYPICAL VALUE
Tensile Strength	ASTM D 412	psi	1200 (min)	1200
Percent Elongation	ASTM D 412	%	350 (min)	431
100% Modulus	ASTM D 412	psi	400 (min)	680
Tear Resistance	ASTM D 1004	lb/in	175 (min)	232
Shore A Hardness 5 second interval reading	ASTM D 2240	points	76 ± 6	82
Hydrostatic Head Section 615-5	FHA 4900.1		no moisture penetration	pass at 2 ft.
Water Vapor Transmission Rate	ASTM E 96E Proc. A	perms	n/a	0.07
Shrinkage	ASTM D 1204	%	5 (max)	2.5
Low Temperature Flexibility at -22°F	ASTM D 2136		no cracking or breaking	pass
Chemical Resistance: Sodium Hydroxide a. Weight Change	ASTM D 543	%	± 5 (max)	-3.1
Microorganism Resistance a. Weight Change	Soil Burial	%	± 5 (max)	-2.7

DETAILS

FIG. 1
SHOWER PAN

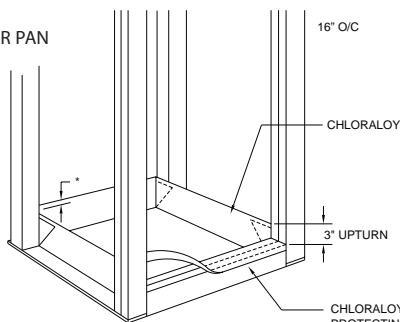

*NAILS USED TO SECURE CHORALOY TO BLOCKING/JOISTS SHOULD BE IN UPPER 1/2" OF UPTURNS.

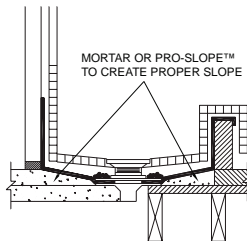

MORTAR OR PRO-SLOPE™ TO CREATE PROPER SLOPE

FIG. 2
DRAIN

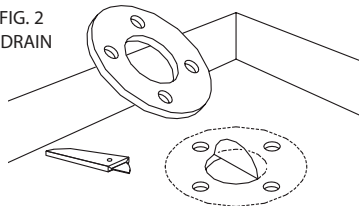

USE DRAIN BODY AS CUTTING TEMPLATE

FIG. 3
CORNERS

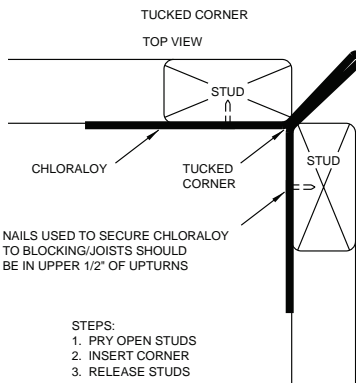

NAILS USED TO SECURE CHORALOY TO BLOCKING/JOISTS SHOULD BE IN UPPER 1/2" OF UPTURNS

STEPS:
1. PRY OPEN STUDS
2. INSERT CORNER
3. RELEASE STUDS

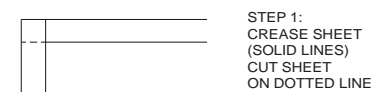

STEP 1:
CREASE SHEET
(SOLID LINES)
CUT SHEET
ON DOTTED LINE

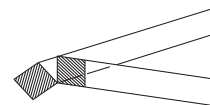

STEP 2:
FOLD AND
SEAL WITH
NOBLESEALANT 150

LAP CORNER

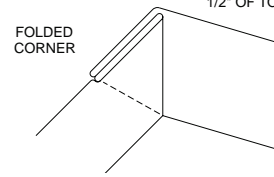

SUPPORT UPTURN BY
NAIL, STAPLE, OR SHEET
METAL SCREW WITHIN
1/2" OF TOP

FOLDED CORNER

PREFORMED CORNERS

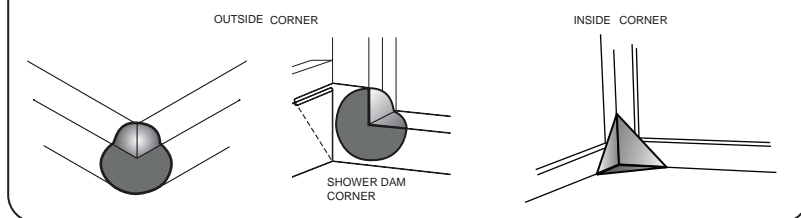

OUTSIDE CORNER

INSIDE CORNER

SHOWER DAM CORNER



INSTALLATION INSTRUCTIONS FOR CHLORALOY® 240 (CPE)

1. PRODUCT

- 1.1 Chloraloy 240: Sheet membrane made from Chlorinated Polyethylene (CPE), 1 mm (.040") nominal thickness, gray in color. Designed to function as a waterproofing (and/or cleavage) membrane under a full mortar bed installation of ceramic tile, dimension stone or terrazzo tile.
 - 1.2 Chloraloy 240 meets these requirements for shower pan liner: ASTM D 4068, International Plumbing Code (IPC), and IAPMO FILE 3046.
 - 1.3 **Limitations:**
 - a) Tile cannot be directly bonded to Chloraloy. A reinforced mortar bed is generally laid over Chloraloy. Tile can then be thin-set to the mortar bed. See TCNA guidelines.
 - b) Chloraloy 240 may not be exposed to direct sunlight for more than 48 hours.
 - 1.4 For applications not detailed herein, contact Noble Company.
-

2. PREPARATORY WORK

- 2.1 The structural floor or substrate must be clean, smooth and free of holes, cracks and sharp projections. Nail heads should be driven flush or recessed.
 - 2.2 Blocking between studs is recommended to support upturned membrane.
HINT: Notching the studs at each corner approximately 1/8" will provide space for folded Chloraloy corners and prevent backer board from bowing. If metal studs are used, the backer board can be "shimmed" slightly to provide space for the folded corners.
 - 2.3 Substrate should be sloped per code requirements with no depressions where ponding could occur.
 - 2.4 Where drains are incorporated into the installation (e.g. showers, commercial kitchens, decks, etc.), the substrate must be sloped towards the drain.
 - 2.5 Drains must be equipped with proper clamping devices and weep holes. Inspect for warpage of clamping ring or drain body. Rotating clamping ring may improve seal. Replace drains warped over .040". When reusing existing drain, clean rust, caulk, mortar, etc., from face of clamping ring and matching surface on drain. Use NobleSealant 150 to form watertight seal between Chloraloy and the drain body.
-

3. MATERIALS FOR INSTALLATION

- 3.1 Chloraloy 240 sheet membrane. Preformed corners as required. NobleSealant 150 (see tube for coverage) for seaming, sealing, and to caulk drains. Knife or scissors, and hand roller.
Note: NobleWeld 100 solvent seaming cement (spread rate 100 l.f./qt.) can also be used to seam sheets of Chloraloy.
 - 3.2 Use hot air gun to expedite curing of solvent weld or when temperature is below 7°C (45°F).
-

4. PROCEDURE

- 4.1 **PAN:** Line the area with Chloraloy 240. Allow for upturn when cutting sheet (see 4.2 and Figure 1).
NOTE: Rolls of Chloraloy are marked on each side with blue lines at approximately 6" intervals. These marks are intended to be used as guidelines, not accurate measurements.
- 4.2 The upturn should be 3" above the finished dam or floodplane as specified or required by code. Membrane should be flashed behind the backer board.
- 4.3 Turn the sheet up on all sides using folded corners (see Figure 3), or use preformed inside corners as needed.
- 4.4 Secure the liner to the backing or studs with nails or staples in top 1" of flashed membrane. Install upturn at dam over the top and fasten on outside face. Where metal studs are used and no backup material is provided, use sheet metal screws and washers. Fold the material over 1" at the top to give extra strength and fasten it to the studs. Where walls are concrete or block, use masonry nails, screws with washers or NobleSealant 150. Follow directions on label.
- 4.5 **PREFORMED DAM CORNERS:** Protects against water leakage at the junction of the shower opening and the dam. Recommended even when not required. To install corners, use NobleSealant 150 and follow seaming and joining procedures for NobleSealant 150.
- 4.6 **DRAINS:** Press firmly on the Chloraloy using drain body as a cutting template to cut the opening.
CAUTION: When cutting bolt holes, do not cut beyond outside perimeter of clamping area (see Figure 2). Snug bolts evenly and then tighten firmly to make a watertight seal. Apply a bead of NobleSealant 150 under the sheet over the clamping ring drain body.
- 4.7 **PENETRATIONS:** If it becomes necessary to penetrate the membrane below the waterline or in any other critical area, use a piece of Chloraloy 240 3" larger (all sides) than damaged area and secure in place (see 4.8.1 - 4.8.2)
- 4.8 **SEAMING AND JOINING PROCEDURES:** When the area to be waterproofed is wider than the width of a sheet, sheets may be seamed (joined) using NobleSealant 150 or NobleWeld 100. Both methods provide permanent, waterproof seams.
CAUTION: Bonding area must be dry, clean and free of dust, dirt, oil and grease.

- 4.8.1 **NOBLESEALANT 150** (see instructions on tube).
- Lay out sheets to overlap approximately 2" and mark.
 - Apply one 3/16" bead of NobleSealant 150 about 3/4" from the edge of first sheet.
 - Overlap first sheet and flatten bead with hand roller, trowel or putty knife.
- 4.8.2 **NOBLEWELD 100** (see instructions on can).
- NOTE:** Do not leave NobleWeld 100 open while fabricating seams as the solvent quickly dissipates. Apply from can and spread with 1" to 2" natural bristle brush.
- Allow 2" for lap seam. Use a minimum of 6" strip for cap seam.
 - Only work 2' to 3' of seam at a time.
 - Clean by lightly applying Xylene or alcohol. Immediately wipe with clean, lint-free cloth.
 - Roughen both surfaces to be bonded with copper scrub pad or clean wire brush.
 - Apply NobleWeld 100 liberally and evenly to both surfaces approximately 1" wider than finished seam.
DO NOT ALLOW SOLVENT TO DRY. Material should be soft, wet and tacky. Should solvents dry before completing seam, re-apply.
 - Close seam while CPE is soft and still wet with solvent. **CAUTION:** See 4.8.2 (i).
 - Use roller, putty knife or rub seam with cloth to remove excess solvent and eliminate air bubbles.
NOTE: The application of heat improves the efficiency of seaming at low temperatures. A hot air gun is recommended to cure seam below 7°C (45°F).
 - To insure continuous seam, peel seam back several inches into just-completed section before starting next section.
 - Seams must be allowed to cure to develop strength. Do not stress until allowed to cure for 24 hours at 21°C (70°F) and 40% relative humidity. Cure times may be reduced by heating.
NOTE: Seam may be water tested after curing (at least 30 minutes).
- 4.9 **TESTING:** Test installation by filling pan with water. Inspect for leakage. If leaking is detected, first re-tighten clamping ring, then inspect ring to be certain it mates with the drain body and is not warped. If defective, replace. It may be possible to seal by welding a second layer of Chloraloy 240 in area of drain body and/or sealing with NobleSealant 150. Repeat testing until no leaks can be detected.
- TIP:** To protect liner from damage, water may be left in pan.

DETAILS

FIG. 1
SHOWER PAN

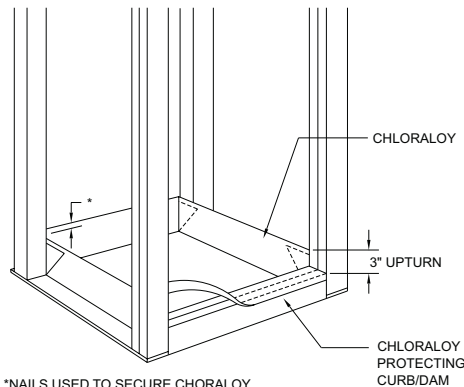

*NAILS USED TO SECURE CHORALOY TO BLOCKING/JOISTS SHOULD BE IN UPPER 1/2" OF UPTURNS.

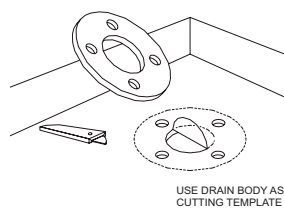
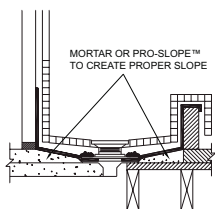
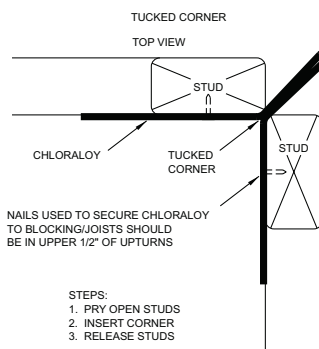

FIG. 3
CORNERS



STEPS:
1. PRY OPEN STUDS
2. INSERT CORNER
3. RELEASE STUDS

STEP 1:
GREASE SHEET (SOLID LINES)
CUT SHEET ON DOTTED LINE

STEP 2:
FOLD AND SEAL WITH NOBLESEALANT 150

LAP CORNER

SUPPORT UPTURN BY NAIL, STAPLE, OR SHEET METAL SCREW WITHIN 1/2" OF TOP

FOLDED CORNER

PREFORMED CORNERS

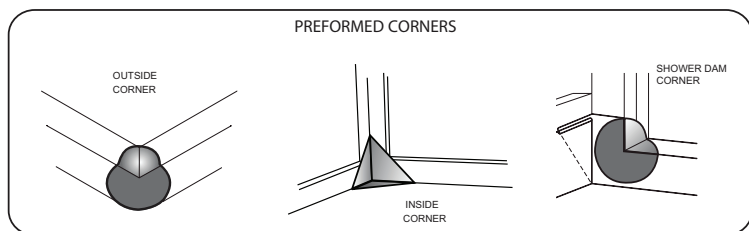

NOTE: CHLORALOY 240 MUST BE INSTALLED IN COMPLIANCE WITH LOCAL CODES, APPROPRIATE ANSI STANDARDS AND TCNA RECOMMENDATIONS. SEE INSTALLATION INSTRUCTIONS FOR MORE DETAILS. CONTACT NOBLE COMPANY FOR OTHER INFORMATION.



P.O. Box 350 · Grand Haven, MI 49417-0350 · 800-878-5788 · Fax: 231-799-8850 · www.noblecompany.com
© Registered Trademark of Noble Company, Grand Haven, MI

Form Chl Inst 02/11
Supersedes Chl Inst 1/08