

# OPERATION AND PARTS MANUAL

## **Multiquip Submersible Pump Model ST-3050D**

© COPYRIGHT 2002, MULTQUIP INC.

Revision #1 (11/18/02)



**MULTQUIP INC.**  
18910 WILMINGTON AVENUE  
CARSON, CALIFORNIA 90746  
310-537-3700  
800/421-1244 NATIONWIDE  
FAX: 310-537-3927

**PARTS DEPARTMENT:**  
800/427-1244  
FAX: 800/672-7877  
**SERVICE DEPARTMENT:**  
800/478-1244  
FAX: 310-537-4259

## **HERE'S HOW TO GET HELP**

*PLEASE HAVE THE MODEL AND SERIAL NUMBER  
ON-HAND WHEN CALLING*

### ***PARTS DEPARTMENT***

*800/427-1244 or 310/537-3700*

*FAX: 800/672-7877 or 310/637-3284*

### ***SERVICE DEPARTMENT***

*800/478-1244 or 310/537-3700*

*FAX: 310 - 537-4259*

### ***WARRANTY DEPARTMENT***

*800/421-1244, EXT. 279 or 310/537-3700*

*FAX: 310 - 537-1173*

### ***MAIN***

*800/421-1244 or 310/537-3700*

*FAX: 310 - 537-3927*

# ST-3050D SUBMERSIBLE PUMP — TABLE OF CONTENTS

Here's How To Get Help .....	2
Table Of Contents .....	3
Parts Ordering Procedures .....	4
Safety Message Alert Symbols .....	5
Rules For safe Operation .....	6-7
Specifications (Pump) .....	7
General Information .....	9

## ST-3050D Submersible Pump

Components .....	10
Application (Float Switches) .....	11
Control Boxes .....	12
Control Box Installation (CB200) .....	13
230/460 VAC Voltage Selection .....	14
Pump Wiring Diagram .....	15
Transformer Wiring Diagram (CB200) .....	16
Control Box Wiring Diagram (CB200) .....	17
Three-Phase Power Installation (CB200) .....	18-19
Control Box Pre-Setup (CB200) .....	20-21
Control Box Installation (MP102/104) .....	22
Control Box Wiring Diagram (MP102/104) .....	23
Operation .....	24-25
Maintenance .....	26
Pump Troubleshooting/Performance Curve .....	27
Explanation Of Codes In Remarks Column .....	28
Suggested Spare Parts .....	29
Electric Submersible Pump Assembly .....	30-33
Electric Motor Assembly .....	34-35
Terms and Condition of Sale — Parts .....	36

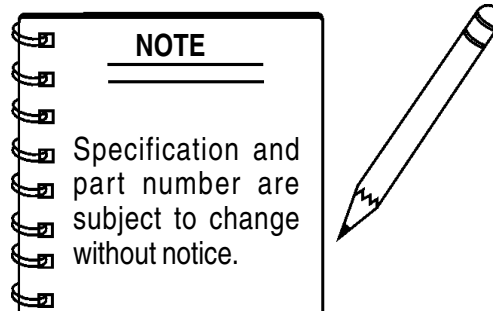

# PARTS ORDERING PROCEDURES

- Dealer account number
- Dealer name and address
- Shipping address (if different than billing address)
- Return fax number
- Applicable model number
- Quantity, part number and description of each part
- Specify preferred method of shipment:
  - UPS Ground
  - UPS Second Day or Third Day\*
  - UPS Next Day\*
  - Federal Express Priority One (please provide us with your Federal Express account number)\*
  - Airborne Express\*
  - Truck or parcel post

*\*Normally shipped the same day the order is received, if prior to 2PM west coast time.*

## Earn Extra Discounts when you order by FAX!

All parts orders which include complete part numbers and are received by fax qualify for the following extra discounts:

<u>Number of line items ordered</u>	<u>Additional Discount</u>
1-9 items	3%
10+ items**	5%

### Get special freight allowances when you order 10 or more line items via FAX!\*\*

- UPS Ground Service at no charge for freight
- UPS Third Day Service at one-half of actual freight cost

No other allowances on freight shipped by any other carrier.

\*\*Common nuts, bolts and washers (all items under \$1.00 list price) do not count towards the 10+ line items.

\*DISCOUNTS ARE SUBJECT TO CHANGE\*

Fax order discount and UPS special programs revised June 1, 1995

**Extra Fax Discount  
for Domestic USA  
Dealers Only**

**Up to 5%  
extra savings!**

**UPS  
Special**  
For faxed orders only

**Now! Direct TOLL-FREE access  
to our Parts Department!**

Toll-free nationwide:

800-421-1244

Toll-free FAX:

800/6-PARTS-7 • 800-672-7877

# ST-3050D SUBMERSIBLE PUMP— SAFETY MESSAGE ALERT SYMBOLS

## FOR YOUR SAFETY AND THE SAFETY OF OTHERS!

Safety precautions should be followed at all times when operating this equipment. Failure to read and understand the Safety Messages and Operating Instructions could result in injury to yourself and others.

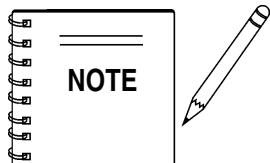

This Owner's Manual has been developed to provide complete instructions for the safe and efficient operation of the Multiquip **Model ST-3050D Submersible Pump**. Before using this pump, ensure that the operating individual has read and understands all instructions in this manual.

## SAFETY MESSAGE ALERT SYMBOLS

The three (3) Safety Messages shown below will inform you about potential hazards that could injure you or others. The Safety Messages specifically address the level of exposure to the operator, and are preceded by one of three words: **DANGER**, **WARNING**, or **CAUTION**.



**DANGER:** You **WILL** be **KILLED** or **SERIOUSLY** injured if you do not follow directions.



**WARNING:** You **CAN** be **KILLED** or **SERIOUSLY** injured if you do not follow directions.

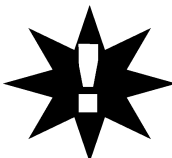

**CAUTION:** You **CAN** be injured if you do not follow directions.

Potential hazards associated with the ST-3050D submersible pump operation will be referenced with Hazard Symbols which appear throughout this manual, and will be referenced in conjunction with Safety Message Alert Symbols.

## HAZARD SYMBOLS

### Rotating Parts



**NEVER** operate equipment with covers, or guards removed. Keep fingers, hands, hair and clothing away from all moving parts to prevent injury.

### Accidental Starting



**ALWAYS** place the power source circuit breaker or ON/OFF switch in the **OFF** position, when the pump is not in use.

### Sight and Hearing hazard

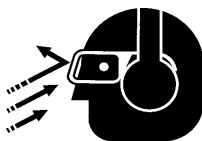

**ALWAYS** wear approved eye and hearing protection, if required.

### Respiratory Hazard



**ALWAYS** wear approved respiratory protection, if required.

### Equipment Damage Messages

Other important messages are provided throughout this manual to help prevent damage to your submersible pump, other property, or the surrounding environment.

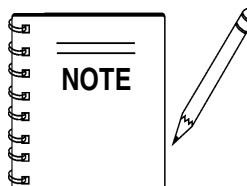

This submersible pump, other property, or the surrounding environment could be damaged if you do not follow instructions.

# ST-3050D SUBMERSIBLE PUMP — RULES FOR SAFE OPERATION

## CAUTION:

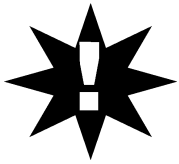

Failure to follow instructions in this manual may lead to serious injury or even death! This equipment is to be operated by trained and qualified personnel only! This equipment is for industrial use only.

The following safety guidelines should always be used when operating the ST-3050D Submersible Pump:

### GENERAL SAFETY

- **DO NOT** operate or service this equipment before reading this entire manual.



- This equipment should not be operated by persons under 18 years of age.

- **NEVER** operate this equipment without proper protective clothing, shatterproof glasses, steel-toed boots and other protective devices required by the job.



- **NEVER** operate this equipment when not feeling well due to fatigue, illness or taking medicine.



- **NEVER** operate this equipment under the influence of drugs or alcohol.



- **NEVER** use accessories or attachments, which are not recommended by Multiquip for this equipment. Damage to the equipment and/or injury to user may result.

- Manufacture does not assume responsibility for any accident due to equipment modifications.

- Whenever necessary, replace nameplate, operation and safety decals when they become difficult read.

- **ALWAYS** check the machine for loosened threads or bolts before starting.

- **NEVER** operate the submersible pump in an explosive atmosphere or near combustible materials. An explosion or fire could result causing severe **bodily harm or even death**.

- **ALWAYS** make sure submersible pump is grounded.

- **NEVER** use gas piping as an electrical ground.

- **DO NOT** place hands or fingers inside pump when pump is running.

- **ALWAYS** make certain that the voltage supplied to the pump is correct. Always read the pump's nameplate to determine what the power requirements are (230 or 460 VAC 3 phase).

- **DO NOT** restrict the flow of the discharge hose as it may cause overheating.

- Be careful of discharge whipping under pressure.

- Make sure pump installation is accordance with national and local electrical codes.

- **ALWAYS** have a qualified electrician perform the pump wiring installation.

- **ALWAYS** mount the control box in a vertical position protected from the elements.

- **NEVER** handle pump's AC power cord with **wet hands**.

- **NEVER** let an extension cord or plug connection **lay in water**.

- **NEVER stand in water** while AC power cord is connected to a power source.

- **NEVER** use a pump with a defective, frayed power cord. Check the power cord on the pump for cuts in the insulation.

- **NEVER** use a extension cord that is frayed or damaged where the insulation has been cut.

- **ALWAYS** make certain that proper extension cord has been selected for the job See Table 3.

- **NEVER** attempt to use the power cord as a lifting or lowering device for the submersible pump.

- When raising or lowering of the submersible pump is required, always attach an adequate rope or lifting device to the correct lifting point (handle) on the pump.

- **ALWAYS** place the pump in an up-right position on a platform before using. The platform will prevent the pump from burrowing itself on soft sand or mud.

- **NEVER** operate pump on its side.

- **DO NOT** allow the pump to freeze in water.

- **NEVER** leave an open pump chamber unattended.

- The electrical voltage required to operate the pump can cause severe injury or even death through physical contact with live circuits. **ALWAYS** disconnect the electrical power from the pump before performing maintenance on the pump.

# ST-3050D SUBMERSIBLE PUMP — RULES FOR SAFE OPERATION

- **ALWAYS** make sure that electrical circuits are properly *grounded* per the *National Electrical Code* (NEC) and local codes before operating pump. Severe injury or death by electrocution can result from operating an ungrounded pump.
- **NEVER** use this pump to remove water from a swimming pool when people are in the water.
- **ALWAYS** be sure the operator is familiar with proper safety precautions and operations techniques before using submersible pump.
- **ALWAYS** check pump oil level only when pump is cool. Expansion due to heat may cause hot! oil to spray from the oil plug when the oil plug is removed.
- **DO NOT** attempt to thaw-out a frozen pump by using a torch or other source of flame. Application of heat in this manner may heat the oil in the seal cavity above the critical point, causing pump damage.
- **DO NOT** pump water greater than 104 degrees Fahrenheit. Also **DO NOT** pump liquids containing acid or alkali.
- **ALWAYS** check the dual voltage connection inside the pump for proper voltage setting.
- **ALWAYS** check strainer before pumping. Make sure strainer is not clogged. Remove any large objects, dirt or debris from the strainer to prevent clogging.
- **ALWAYS** use a large basket strainer when pumping water that contain large debris.
- **ALWAYS** flush pump (clean) after use when pumping water concentrated with heavy debris. It is very important to always flush the pump before turning it off to prevent clogging.
- **ALWAYS** store equipment properly when it is not being used. Equipment should be stored in a clean, dry location out of the reach of children.
- **ALWAYS** read, understand, and follow procedures in Operator's Manual before attempting to operate equipment.

## Maintenance Safety

- **NEVER** lubricate components or attempt service on a running machine.
- **ALWAYS** allow the machine a proper amount of time to cool before servicing.
- Keep the machinery in proper running condition.
- Fix damage to the machine immediately and always replace broken parts.

## Emergencies

- **ALWAYS** know the location of the nearest *fire extinguisher*.



- **ALWAYS** know the location of the nearest and *first aid kit*.



- In emergencies *always* know the location of the nearest phone or *keep a phone on the job site*. Also know the phone numbers of the nearest *ambulance, doctor* and *fire department*. This information will be invaluable in the case of an emergency.

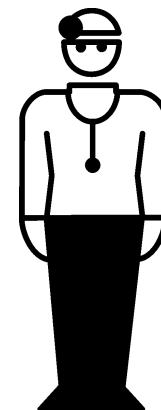
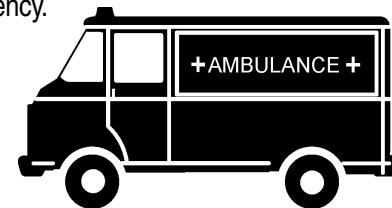
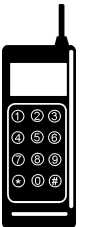

# ST-3050D SUBMERSIBLE PUMP — SPECIFICATIONS

**Table 1. Specifications (Pump)**

	Model	ST-3050D
<b>Pump</b>	Type	Submersible Trash Pump
	Suction & Discharge Size	3.00 in. (76 mm.)
	Maximum Pumping Capacity	270 gallons/minute (1,022 liters/minute)
	Max. Solids Diameter	2.00 in. (51 mm.)
	Max. Lift	25 ft. (7.62 meters)
	Max. Head	86 ft. (26.00 meters)
	Power	5 HP (3.75 Kw)
	Voltage Phase	230/460 3Ø
	Starting Amps	77 @ 230 VAC 39 @ 460 VAC
	Running Amps	14.2 @ 230 VAC 7.1 @ 460 VAC
	Control Box Required	Yes
	Thermal Overload Protection	Yes
	Rotation	Counter-Clockwise <sup>1</sup>
	Mechanical Oil Seal Capacity	180 cc. (.18 Liters) <sup>2</sup>
	Impeller Clearance	.012 -.025 in. (.304 - .635 mm.)
	RPM (Speed)	3,550 ± 30
	Power Cable Length	25 FT. (7.62 Meters)
Dimensions (Height X Diameter)	10.2 x 26.8 in. (25.9 X 68 cm.)	
Dry Net Weight	120 lbs. (54 Kg.)	

- Motor Rotation** – Upon start-up, the pump "kicks" in the opposite direction of motor rotation. The correct rotation is counter-clockwise (CCW) as viewed from the impeller end of the pump. Rotation direction for 3-phase pumps is changed by reversing two of the power leads.
- Mechanical Oil Seal** – Use a good grade 10 weight non-detergent hydraulic oil (i.e. Shell Turbo 32 or equivalent). Fill oil cavity 75% to 85% full (allow air space for expansion).



# ST-3050D SUBMERSIBLE PUMP — GENERAL INFORMATION

## Introduction

The Multiquip Model ST-3050D submersible pump is designed to pump water and is used for the draining (de-watering) of swimming pools, well casings construction sites, cofferdams, manholes, transformer vaults and excavations.

A vortex type impeller is attached to the output shaft of a 5.0 HP electric motor which provides adequate power for general purpose pumping. This submersible pump is supplied complete with an electric power cable, and a discharge port located at the top of the pump which accepts a 3-inch hose.

This pump is ideal for portability because of its light weight and carrying handle. For reliability and long life, a mechanical seal provides shaft sealing, with an oil chamber separating the pump section from the motor.

The pump when in use, should be installed as free standing (upright position) on its strainer base. A 3-inch discharge hose (not supplied) should be connected to the discharge port located on top of the pump. The discharge hose should be adequately supported to avoid stress on the pump.

For maximum water flow, the discharge hose should be kept as short as possible, and with minimum elevation above the pump. Remember as the length and/or height of the discharge hose is increased, the flow of water will be reduced. Also any reduction in the hose size, and any fittings such as valves or outlet nozzles, will restrict the water flow.

To avoid back-siphonage when the pump is switched off, ensure that the end of the discharge hose is installed above the water level at the final discharge point.

When the pump is switched off, the water remaining in the hose will run back through the pump. This can be avoided by placing a non-return valve in the hose nearest the pump.

**NEVER** use this submersible pump to pump flammable liquids or operate in a explosive or flammable environment.

Avoid using this pump in conditions where mud, grit, silt or other debris are present. These conditions could cause blockage and cause excessive pump wear.

**DO NOT** install the pump directly into an area where there is a heavy build-up of mud, grit, silt or debris. If this condition is present, install the pump on a platform before operating.

This pump must always be positioned on a platform in an upright position. **NEVER** operate the pump by a suspended rope. To prevent large solids from entering the pump, install a wire mesh screen or similar barrier around the pump.

If the pump was used to pump water containing mud, silt, use clean water to flush out the pump after each use.

**DO NOT** allow the pump to run dry, as this will damage the pump. During maintenance, dry running is permissible but only for a few seconds.

**NEVER** lift the pump by its electrical power cord. **ALWAYS** lift the pump by its carrying handle or attached a rope to carrying handle.

A pump fully submerged pump in liquid will not freeze, unless the liquid freezes. **DO NOT** allow a partially submerged pump to freeze. The expansion of water freezing in the volute may crack the pump, causing expensive repairs. If there is any danger of the pump being subjected to freezing temperatures, Lift the pump from water and allow it to drain thoroughly.

If the pump jams or the pump rotor locks for any reason, disconnect the pump from the power source immediately. Allowing the pump motor to cycle **ON** and **OFF** under an overload condition can burn out the motor.

When replacement of nuts and bolts is required, use only recommended parts as referenced in the parts section of this manual. This pump uses **metric** threads. **DO NOT** use english measurement threads.

# ST-3050D SUBMERSIBLE PUMP — COMPONENTS

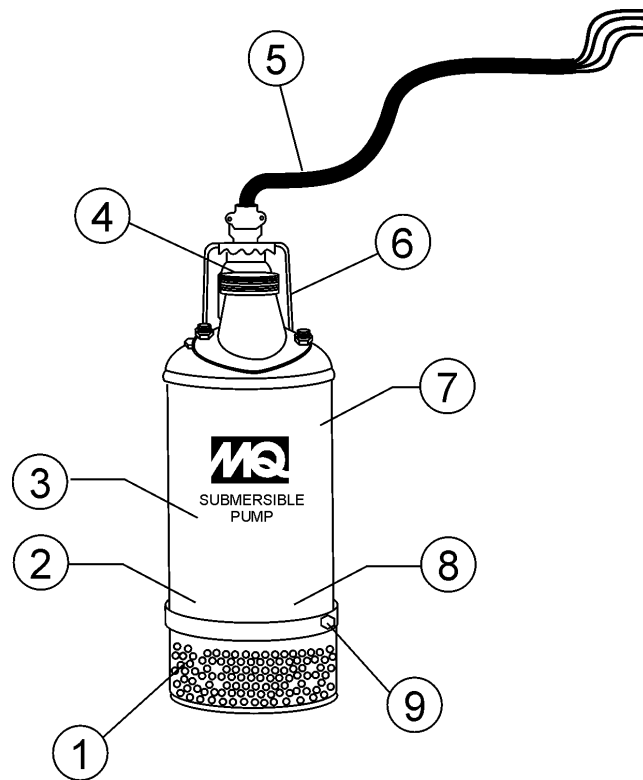

Figure 1. Submersible Pump Components

Figure 1 shows the location of the basic components, for the ST-3050D Submersible Pump. Listed below is a brief explanation of each component.

- 1. Strainer Base** – This strainer base is made of stainless steel which is resistant to hardware corrosion. **DO NOT** pump large objects or debris with this pump. This pump is for pumping water only. For de-watering purposes, always place the strainer base on a platform.
- 2. Volute/Impeller** – Impellers are constructed of high-chrome ductile iron to minimize wear and prolong service life.
- 3. Electric Motor** – This unit utilizes a three-phase, 230/460 VAC, 5.0 HP electric motor. Consult with a licensed electrician before connecting motor to a power source. Observe all city and local safety codes.
- 4. Discharge Port** – Connect a 3-inch hose to this port. Remember to adequately support the discharge hose to avoid stress on the pump.
- 5. AC Power Cable** – This unit is supplied with a 50 ft. (15.24 meters) AC power cable. Always check the cable for signs of wear. **NEVER!** use a defective power cable. Replace the cable immediately if the cable is worn or defective.
- 6. Carrying Handle** – Always carry the submersible pump by its handle. **NEVER!** carry the pump by its power cord. Carrying or lifting the pump by the power cord, will cause undue stress on the cord, and ultimately the cord will become dislodged from the pump.
- 7. Thermal Overload Protection** – This pump will require the use of an external control box with a thermal overload protection device that will shut-down the motor in the event of high operating temperatures. The motor will automatically restart once the temperature returns to an acceptable operating temperature.
- 8. Mechanical Oil Seal** – This oil filled seal provides lubrication when running the pump dry. **NEVER!** run the pump dry. Running the pump dry will cause severe damage to the pump.
- 9. Mechanical Oil Seal Plug** – Remove this plug to check and add hydraulic oil (Shell 32 or equivalent) to the oil cavity. This oil protects the mechanical seal. Oil cavity should be full enough to cover seal spring.

# ST-3050D SUBMERSIBLE PUMP — APPLICATION (FLOAT SWITCHES)

## Float Switch Theory

There is a tilt-sensitive mercury switch hermetically sealed within each float. As the liquid level (water) rises or falls, the float changes its angle until the mercury switch makes (close) or breaks (open) the circuit.

The length of cord between the float and point of attachment determines the amount of water to be pumped.

Contact Multiquip sales department to order float switches.

## Float Switch (Dual)

Float switches (Figure 2) are used for the unattended operation of the submersible pump. The ST-3050D pump requires the use of a control box to perform this function. Shown in Figure 2 is an example of a dual float control switch application.

The Model ST-3050D submersible pump requires one each of the Model SW-1WOP float type mercury switches. These switches have a pumping range level between 5.5~18 feet (1.67~5.5 meters). All float switch connections are bare wire (no plug). The ST-3050D submersible pump **must use** the **CB 200 Control Box** when float switches are required for the job application. The MCP102/104 control boxes **do not** have float switch capability.

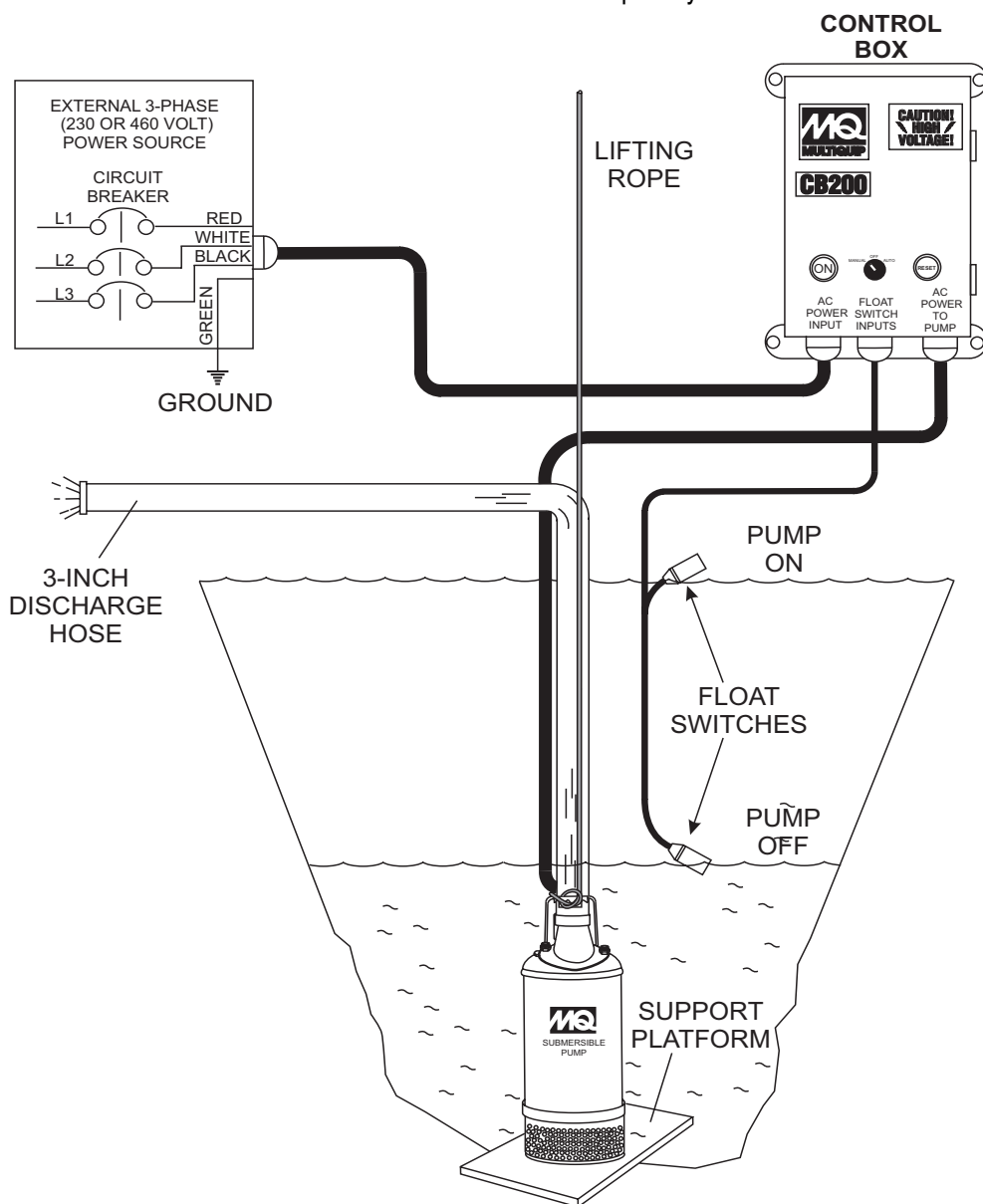

Figure 2. Dual Float Control Switch

# ST-3050D SUBMERSIBLE PUMP — CONTROL BOXES

## Control Boxes

Control boxes (Figure 3) are available for remote control and thermal shut-down capability for the submersible pump. These water resistant control boxes provide electronic overload protection, watertight housing and glands to prevent water from leaking into the box, and a float switch interface.

There are various control box models to choose from, reference Table 2 for the model that meets your pumping requirements.

Contact Multiquip sales department to order control boxes as listed in Table 2.

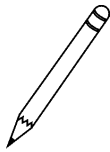
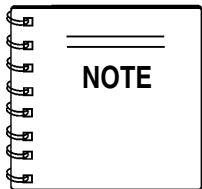

**ALWAYS** have a qualified licensed electrician perform the installation of the control box.

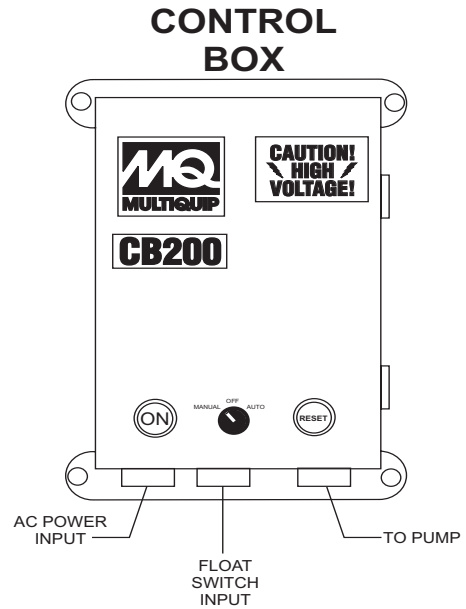

Figure 3. Electrical Control Box (CB-200)

Table 2. Control Box Specifications

Model No.	VoltageType	UL/CSA Listed	Thermal Overload Protection	Float Switch Capability
CB200	230/460 VAC Three-Phase	YES	YES	YES
MCP102	230 VAC Three-Phase	YES	YES	NO
MCP104	460 VAC Three-Phase	YES	YES	NO

# ST-3050D SUBMERSIBLE PUMP/CTRL. BOX — INSTALLATION (CB200)

## DANGER:



To place the ST-3050D submersible pump into operation requires the use of a control box. The control box contains the necessary electronics (electronic overload module, float switch connections and 230/460 voltage transformer) to operate the pump. Remember this control box contains hazardous voltages. Disconnect all sources of power before installing or servicing. There exists the possibility of electrocution, electric shock or burn, which can cause severe bodily harm or even **death!**

## CAUTION:

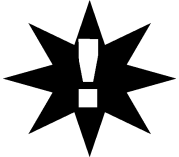

This control box should only be installed or serviced by a licensed electrician or qualified personnel.

### CONTROL BOX MOUNTING

Mount the control box in an **upright vertical position**. Make sure the control box is securely fastened to a flat surface, that is free of dust, dirt, moisture or any elements that may contaminate or erode the electronic components of the control box.

### 3-Phase Power Installation (Input)

The ST-3050D submersible pump requires 230/460 3-phase power for normal operation. The pump is shipped from the factory in the 230 VAC configuration. To change the voltage setting from 230 VAC to 460 VAC refer to the transformer wiring section on page 16.

If you cannot determine what your pump's power requirements are, look at the vendor supplied identification name tag attached to the pump or please contact Multiquip's Service/Technical Assistance department.

## CAUTION:

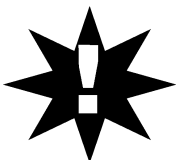

Applying incorrect power (**voltage phasing**) to the submersible pump can cause severe damage to the pump. Please make sure that the correct voltage and phase are transferred to the pump at all times.

### POWER CORD REQUIREMENTS

When routing the three phase power via a power cord to the control box, **ALWAYS** use the correct wire size. Please reference Table 3 below (Cord Length/Wire Size) to determine the correct wire size. Incorrect wire size can adversely affect the performance of the pump.

TABLE 3. CORD LENGTH AND WIRE SIZE

AMPS	50 FT.	100 FT.	150 FT.
6	16 AWG	16 AWG	14 AWG
8	16 AWG	14 AWG	12 AWG
10	16 AWG	14 AWG	12 AWG
12	14 AWG	14 AWG	12 AWG
14	14 AWG	12 AWG	10 AWG
16	12 AWG	12 AWG	10 AWG

### FLOAT SWITCH INSTALLATION (CB200)

1. Remove the float switch input connector housing, then route the float switch wires through the cable gland on the control box. Attach the wires to the float switch terminal block as indicated by Table 2. Reference Figures 7 and 8.

TABLE 4. FLOAT SWITCH CONNECTIONS

FLOAT SWITCH	FLOAT SWITCH TERMINAL BLOCK NUMBER
START	TERMINALS 1 AND 2
STOP	TERMINALS 3 AND 4

2. Tighten the connector housing to ensure a tight fit between the cord and the connector body. This will prevent the cable from pulling out of the terminal block and also prevent moisture from entering the control box..
3. Determine the length of the float switch wires, then secure float switch wires to pump discharge hose.

# ST-3050D SUBMERSIBLE PUMP — 230/460 VAC VOLTAGE SELECTION

## 230/460 VAC Voltage Selection

The ST-3050D submersible pump is factory set at 230 VAC. To change the voltage from 230 VAC to 460 VAC, perform the following:

1. Remove the four retaining screws that secure the power cord gland assembly to the pump casing, and pull the 230 VAC female plug (Figure 4) from the pump's cavity.
2. Un-plug the 230 VAC female plug from the male motor windings plug and insert the 460 VAC female plug into male motor windings plug.
3. Re-install the power cord gland assembly back into the pump's cavity. Make sure that the gland is seated correctly. This will prevent any connector pins from bending or breaking.
4. Insert the four retaining screws and tighten securely

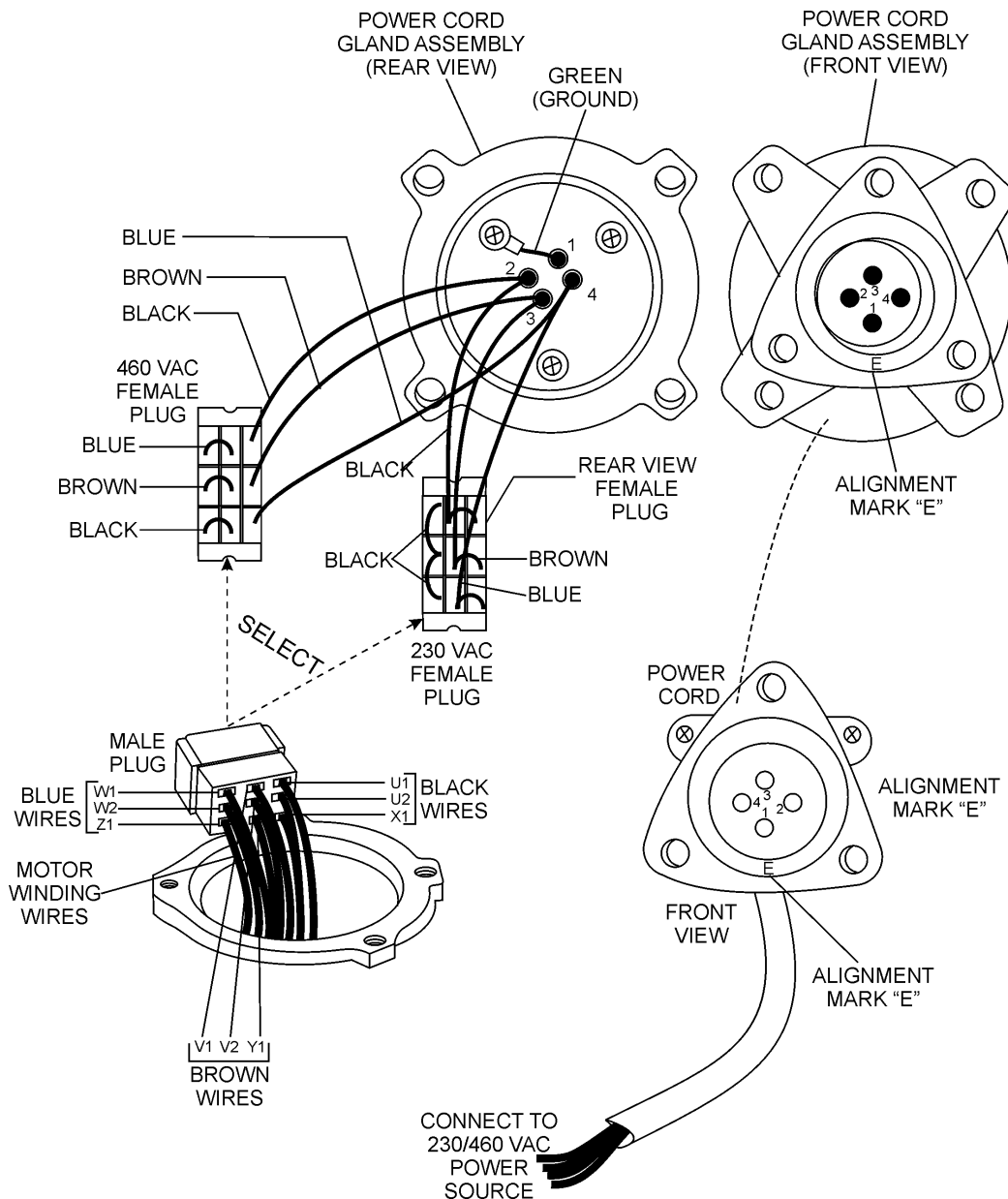
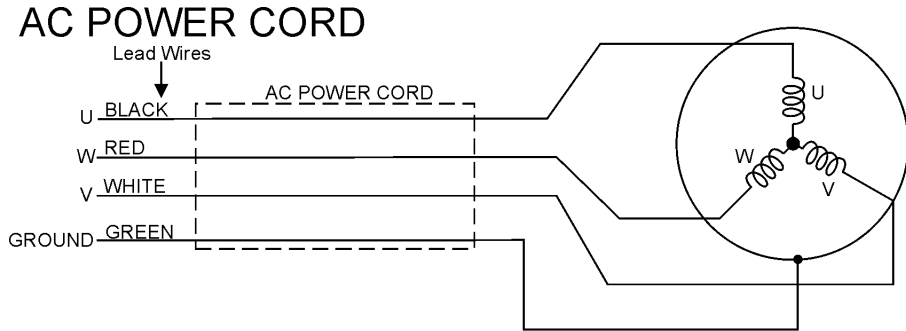
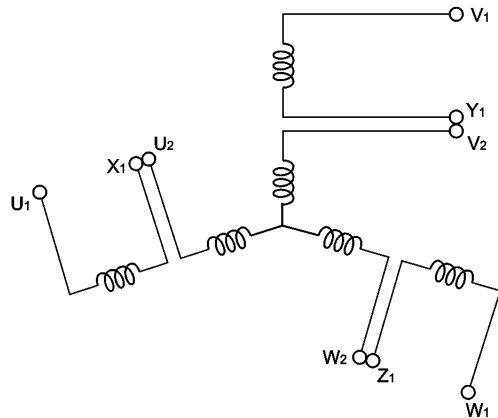

Figure 4. 230/460 VAC Pump Voltage Selection

# ST-3050D SUBMERSIBLE PUMP — PUMP WIRING DIAGRAM



## MOTOR WIRING



## 230 VAC WIRING CONFIGURATION

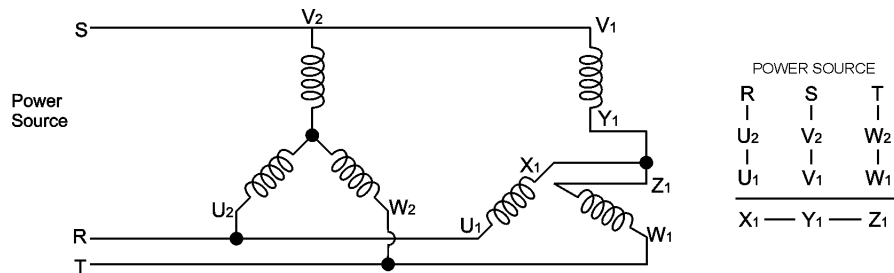

## 460 VAC WIRING CONFIGURATION

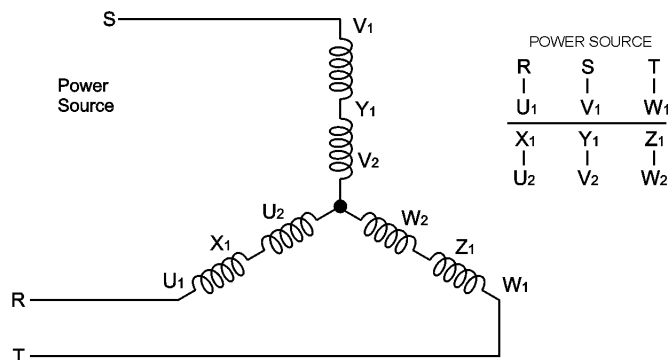
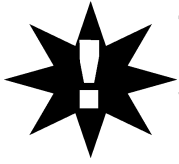

Figure 5. Pump Wiring Diagram

# ST-3050D SUB. PUMP/CTRL. BOX — TRANSFORMER WIRING (CB200)

## TRANSFORMER 230/460 VOLTAGE SETTINGS

### CAUTION:



**Transformer 230/460 Voltage Settings:** Pump motors are factory set at 230 VAC. The transformer (Figure 6) of this control box **must** be set to the voltage requirements of the pump in use. Refer to the attached wiring diagram located inside the "Control Box" or reference Figures 7 & 8.

Use the two supplied **jumper tabs** to set the transformer to the required output voltage.

### WARNING:



**ALWAYS** make sure that the transformer is set to the correct output voltage. Incorrect transformer output voltage settings can cause severe damage to the pump.

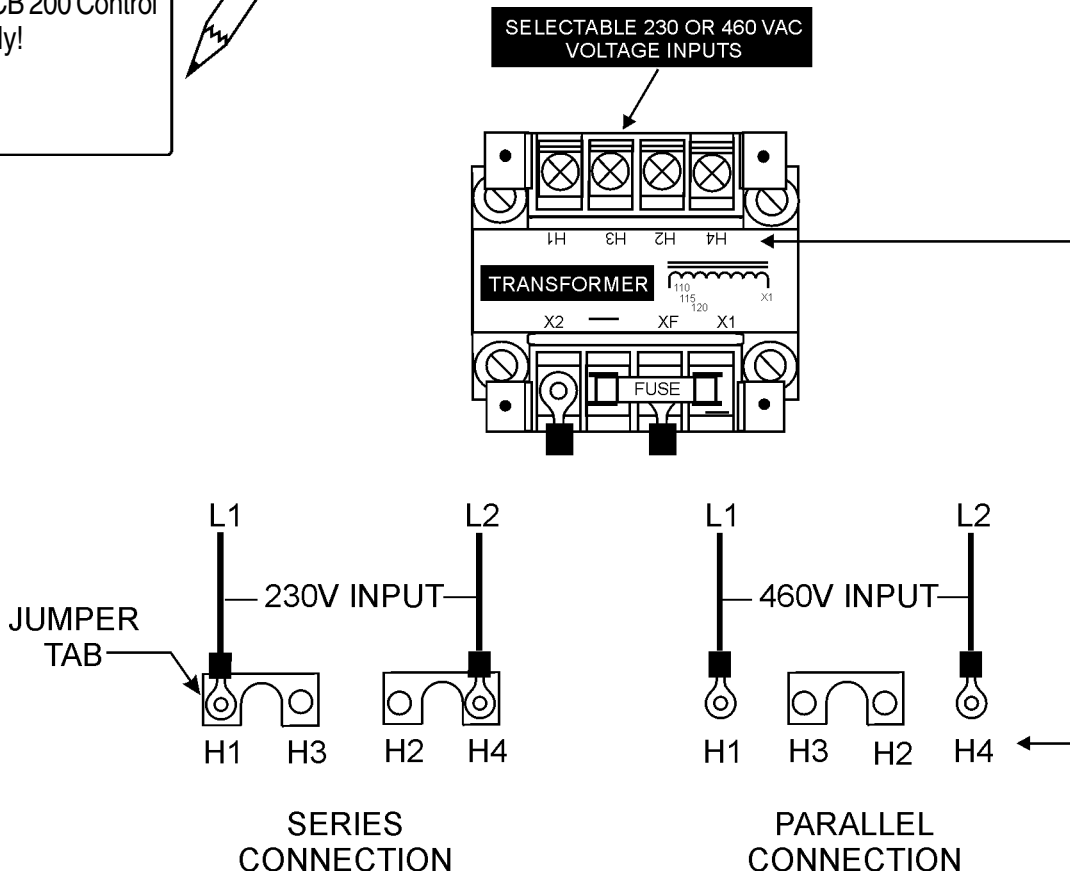
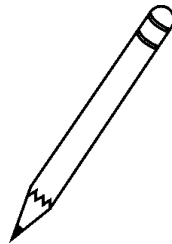
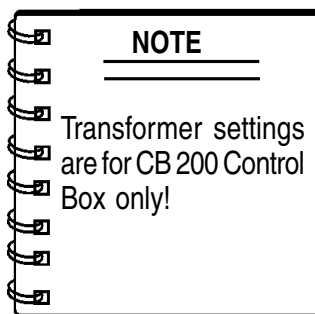
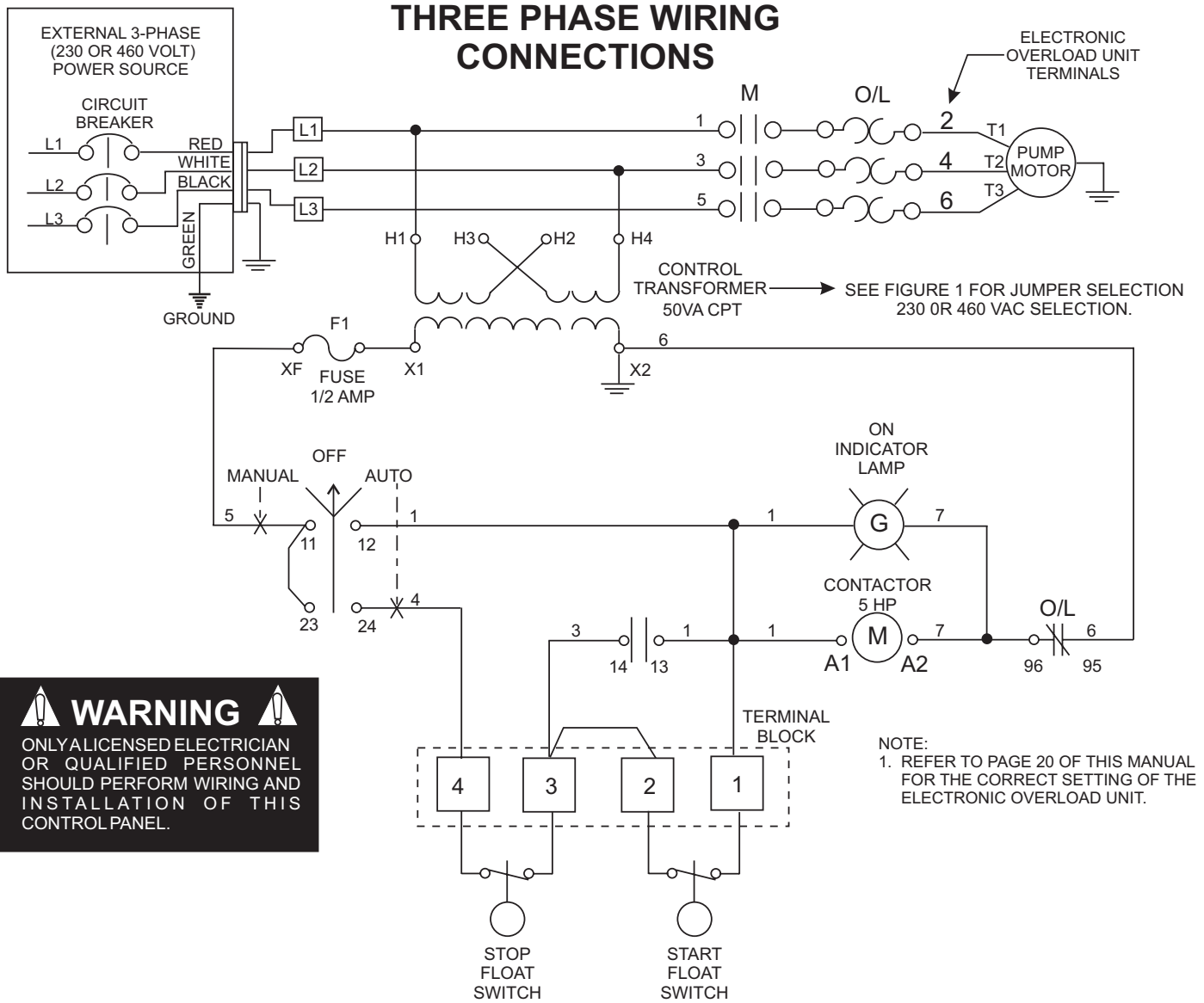

Figure 6. Transformer AC Voltage Settings (Jumper Tabs)



# ST-3050D SUB. PUMP/CONTRL. BOX — WIRING DIAGRAM (CB200)



**WARNING**

ONLY A LICENSED ELECTRICIAN OR QUALIFIED PERSONNEL SHOULD PERFORM WIRING AND INSTALLATION OF THIS CONTROL PANEL.

**Figure 7. Control Box Wiring Diagram**

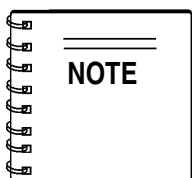

Float switch connections are for use with the CB200 Control Box only!

# ST-3050D SUB. PUMP/CTRL. BOX — 3Ø PWR. INSTALLATION (CB200)

## 3-PHASE POWER CORD (INPUT TO BOX) INSTALLATION

1. The three phase **input** power cord should have four wires. Each wire is color coded. The colors are **RED, WHITE, BLACK** and **GREEN**.
2. Remove the 3-phase AC input connector housing from the control box, then route the three phase input power cable through the cable gland on the control box. Attach the wires to the AC terminal block inside the control box as indicated by Table 5 and Figure 8.

TABLE 5. 3-PHASE AC INPUT POWER CONNECTIONS

CABLE WIRE COLOR	AC TERMINAL BLOCK #
RED	L1
WHITE	L2
BLACK	L3
GREEN	GROUND

3. Tighten the connector housing to ensure a tight fit between the power cord and the connector body. This will prevent the cable from pulling out of the terminal block and also prevent moisture from entering the control box.

It is recommended that the power being supplied to the control box **ALWAYS** be connected to a **circuit breaker** or a **quick disconnect** switch. This safety feature allows for quick removal of power from the control box in the event of an emergency.

4. Connect the other end of the 3-phase input power cord to the voltage source. Remember to provide a means of disconnecting the power from the control box (circuit breaker or quick disconnect switch). Also make sure to provide a good earth ground to the control box.

## 3-PHASE POWER INSTALLATION (OUTPUT TO PUMP)

1. The three phase **output** power cord should have four wires. Each wire is color coded. The colors are **RED, WHITE, BLACK** and **GREEN**.
2. Remove the 3-phase AC output power connector housing on the control box, then route the three phase output power cable through the cable gland on the control box. Attach the wires to the AC terminal blocks on the **electronic overload** unit as indicated by Table 6 and Figure 8.

TABLE 6. 3-PHASE AC OUTPUT POWER CONNECTIONS

CABLE WIRE COLOR	ELECTRONIC OVERLOAD UNIT TERMINAL BLOCK#
RED	2
WHITE	4
BLACK	6
GREEN	GROUND

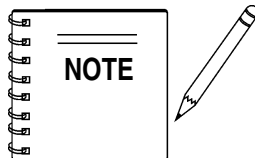

Electrical connections to the power source should only be performed by a **licensed electrician** or **qualified personnel**.

# ST-3050D SUB. PUMP/CTRL BOX — 3Ø PWR. INSTALLATION (CB200)

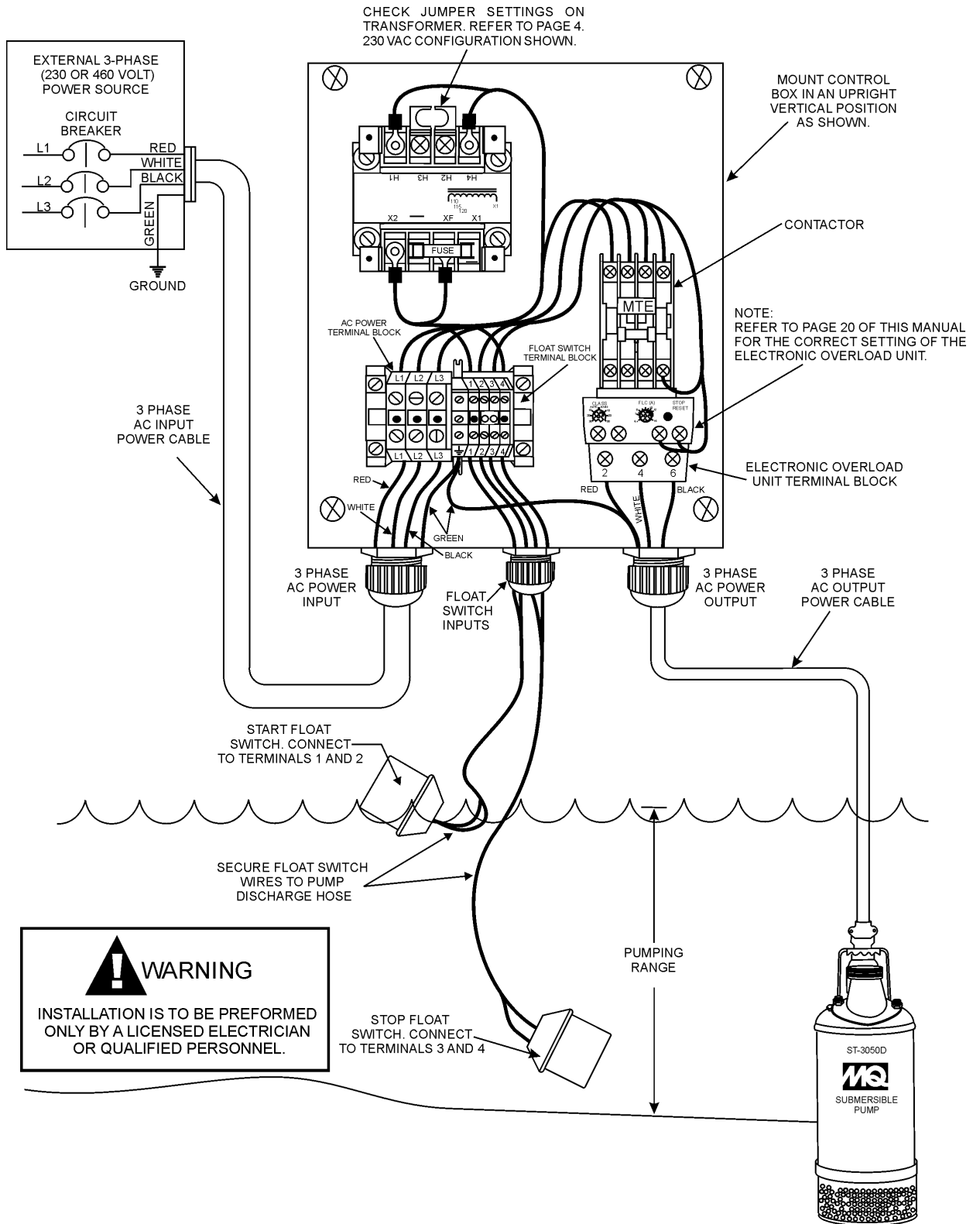

**Figure 8. Three Phase Control Box/Pump System Diagram**

# ST-3050D SUBMERSIBLE PUMP/CTRL. BOX — PRE SETUP (CB200)

## ELECTRONIC OVERLOAD UNIT SETTINGS



**Electronic Overload Unit:** Always make sure that the electronic unit supplied with the control box is set to the correct amperage. This overload unit must **MATCH** the amperage requirements of the pump motor.

Using an electronic overload unit with incorrect settings may result in serious damage to the pump. Refer to the **Pump Amperage Requirements Table** (Table 7), for the correct overload amperage settings.

There are two dials on the **Electronic Overload Unit** (Figure 9) that require adjustment to meet the amperage requirement of the pump motor in use.

These dials are located on top of the overload unit and are labeled **CLASS** and **FLC (A)**.

Use a phillips-head screw driver to adjust the dials to the correct settings.

### FLC (A) Dial Setting

1. Set the **FLC (A)** dial pointer (Figure 9) to the correct amperage for the pump motor in use. Use Table 7, to determine the correct amperage setting.

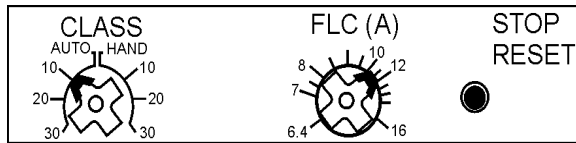

**Figure 9. Electronic Overload Module**

**TABLE 7. PUMP MOTOR AMPERAGE REQUIREMENTS**

Pump Model	Control Box	Volts (VAC)	Amps	Overload Unit
ST3050D Three-Phase	CB200	230	14.2	AXE016-6.40-16A
ST3050D Three-Phase	CB200	460	7.1	AXE016-6.40-16A

### Class Dial Setting

1. Set the **CLASS** dial pointer (Figure 9) to the **HAND** position **10**. This controls the reset function only. It does not affect the ability of the pump to run with or without float switches.

### RESET Operation

This electronic control unit has two modes of reset. The modes are defined as follows:

#### MODE 1

When the **CLASS** dial on the electronic overload module is in the **HAND** position (manual) the reset button (Figure 10) on the front of the control box must be **pushed** to reset the unit (restore power) in the event of an overload.



**Figure 10. Control Box Reset Button**

#### MODE 1

When the **CLASS** dial on the electronic overload module is in the **AUTO** position (automatic mode) the unit will automatically be reset in the event of an overload

### NOTE

All Multiquip **control boxes** should have the **CLASS** dial set to the **HAND** position **10**.

### Operation

1. From the voltage source set the circuit breaker or quick disconnect switch to the **ON** position.
2. For manual operation of the pump, place the 3-position operation switch (Figure 11) on the control box in the **MANUAL** position.

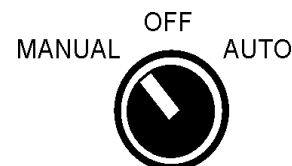

**Figure 11. Manual-Off-On SW. (Man Position)**

# ST-3050D SUBMERSIBLE PUMP/CTRL. BOX — PRE SETUP (CB-200)

3. Verify that the **ON** indicator (Figure 12) on the control box is **LIT**. This means that power is being supplied to the control box.



**Figure 12. Control Box Power ON Indicator**

4. In the manual mode the pump will run continuously. Pay close attention when running the pump in this mode. **DAMAGE** to the pump may occur if pump is not immersed in water.
5. To operate the pump automatically (float switches), place the 3-position operation switch in the **AUTO** position (Figure 13).

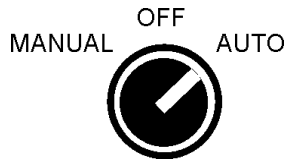

**Figure 13. Manual-Off-On SW. (Auto Position)**

6. In the **AUTO** mode the pump will run as long as there is a sufficient amount of water. This amount is determined by the setting of the float switches. The **stop float** switch contacts will open when the water level is low and power will be removed from the pump's motor.

Once the water level has risen back to the appropriate level the **start float** switch contacts will close and power will be restored to the pump's motor.

## **Shut-Down**

1. Place the 3-position operation switch on the control box to the **OFF** position (Figure 14).

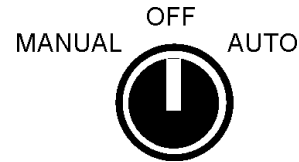

**Figure 14. Manual-Off-On SW. (OFF Position)**

2. Verify that the control box power **ON** light is **OFF**.
3. Turn the circuit breaker or quick disconnect switch to the **OFF** position.

# ST-3050D SUB. PUMP/CTRL. BOX — INSTALLATION (MCP102/104)

## DANGER:



Remember this control box contains hazardous voltages. Disconnect all sources of power before installing or servicing. There exists the possibility of electrocution, electric shock or burn, which can cause severe bodily harm or even **death!**

Remember the **MCP102 Control Box** is to be used only for 230 VAC 3-phase applications and the **MCP 104 Control Box** is for 460 VAC 3-phase applications. Neither control box has float switch capability.

### POWER CORD REQUIREMENTS

When routing the three phase power via a power cord to the control box, **ALWAYS** use the correct wire size. Please reference Table 3 (Cord Length/Wire Size) to determine the correct wire size. Incorrect wire size can adversely affect the performance of the pump.

### CONTROL BOX MOUNTING

Mount the control box in an **upright vertical position**. Make sure the control box is securely fastened to a flat surface, that is free of dust, dirt, moisture or any elements that may contaminate or erode the electronic components of the control box.

### 3-PHASE POWER CORD (INPUT TO BOX) INSTALLATION

1. The three phase **input** power cord should have four wires. Each wire is color coded. The colors are **RED, WHITE, BLACK** and **GREEN**.
2. Remove the 3-phase AC input connector housing from the control box, then route the three phase input power cable through the cable gland on the control box. Attach the wires to the terminal block on the electronic overload unit inside the control box as indicated by Table 5 and Figure 15.
3. Tighten the connector housing to ensure a tight fit between the power cord and the connector body. This will prevent the cable from pulling out of the terminal block and also prevent moisture from entering the control box.

It is recommended that the power being supplied to the control box **ALWAYS** be connected to a **circuit breaker** or a **quick disconnect** switch. This safety feature allows for quick removal of power from the control box in the event of an emergency.

4. Connect the other end of the 3-phase input power cord to the voltage source. Remember to provide a means of disconnecting the power from the control box (circuit breaker or quick disconnect switch). Also make sure to provide a good earth ground to the control box.

### ELECTRONIC OVERLOAD SETTING (230 VAC, 3Ø)

1. Using a small flat-blade screwdriver, set the amperage dial pointer on the electronic overload unit to 14.2 amps.

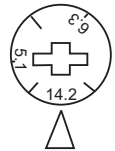

### ELECTRONIC OVERLOAD SETTING (460 VAC, 3Ø)

1. Using a small flat-blade screwdriver, set the amperage dial pointer on the electronic overload unit to 7.1 amps.

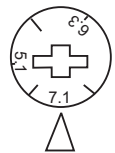

### 3-PHASE POWER INSTALLATION (OUTPUT TO PUMP)

1. The three phase **output** power cord should have four wires. Each wire is color coded. The colors are **RED, WHITE, BLACK** and **GREEN**.
2. Remove the 3-phase AC output power connector housing on the control box, then route the three phase output power cable through the cable gland on the control box. Attach the wires to the AC terminal blocks on the **electronic overload** unit as indicated by Table 6 and Figure 15.

# ST-3050D SUB. PUMP/CTRL. BOX — WIRING DIAGRAM (MCP102/104)

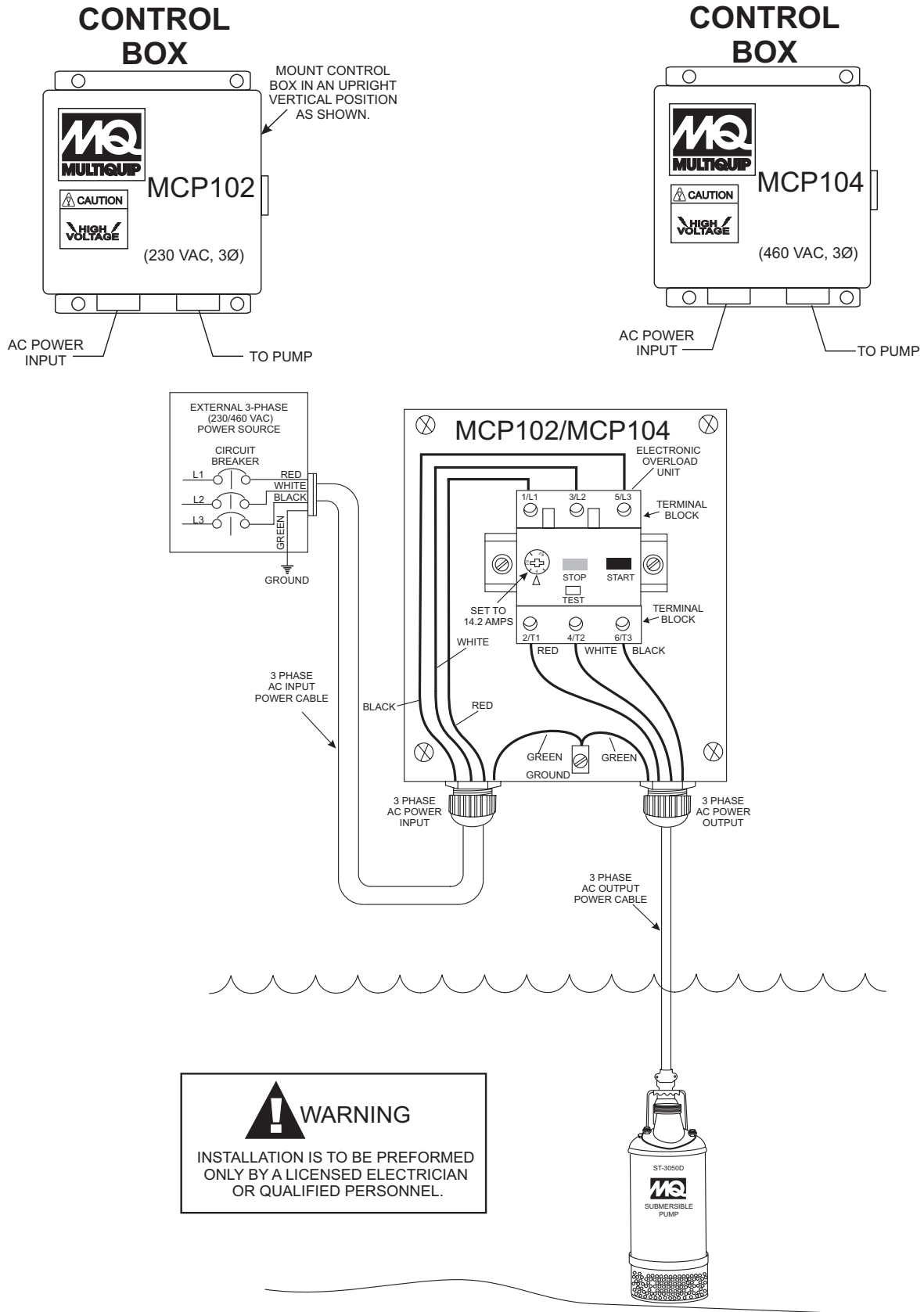
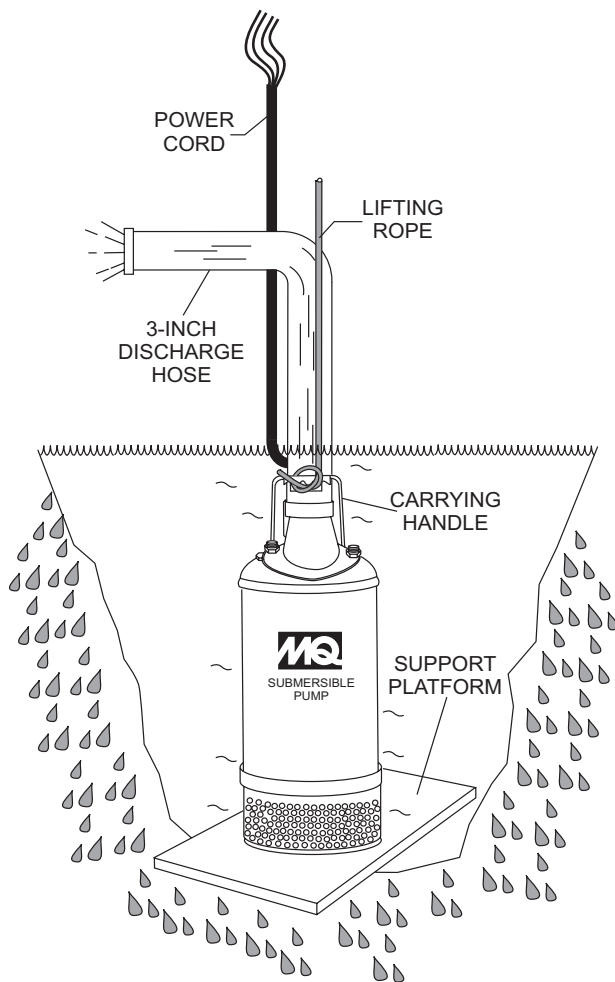

Figure 15. MCP102/104 Control Box Configurations

# ST-3050D SUBMERSIBLE PUMP — OPERATION

## Operation

1. Attach a suitable lifting cable (rope) to the carrying handle (Figure 16) on the pump and lower the pump into place. For applications where there is an excessive amount of mud, grit or silt, the use of a support platform is desirable. When pumping water from swimming pool type applications where there is little or no debris, the support platform is not required.
2. Make sure the pump is always placed in an upright position, not tilted (Figure 17). Never position the pump directly on a soft, loose bottom. Remember to attain maximum pumping capacity and prevent excessive wear, position the pump so it will not burrow itself into sand or clay.



**Figure 16. Submersible Pump Upright Position (Correct)**

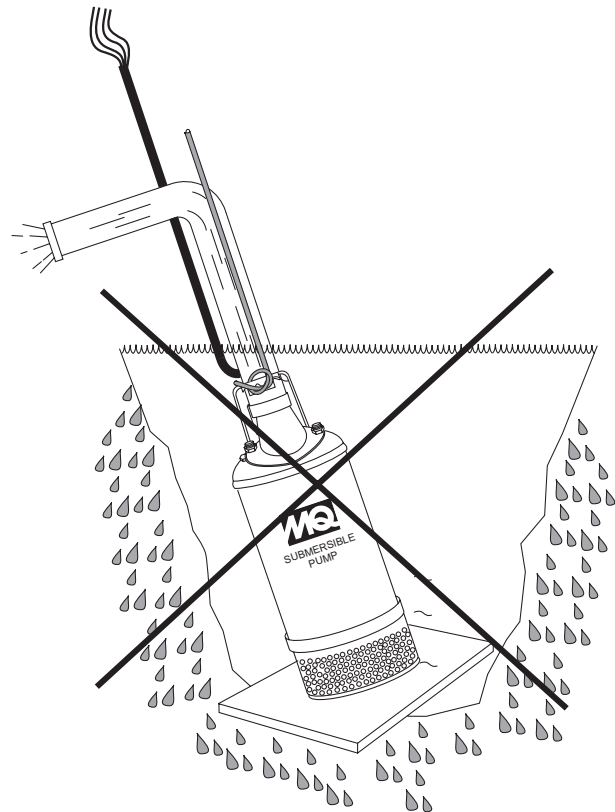

**Figure 17. Submersible Pump Upright Position (Incorrect)**

3. After the pump has been positioned correctly into place, power can be applied to the pump's electric motor.



# ST-3050D SUBMERSIBLE PUMP — OPERATION

4. **NEVER!** grab or touch a live power cord (Figure 18) with wet hands, the possibility exists of **electrical shock**, **electrocution** and even **death**.

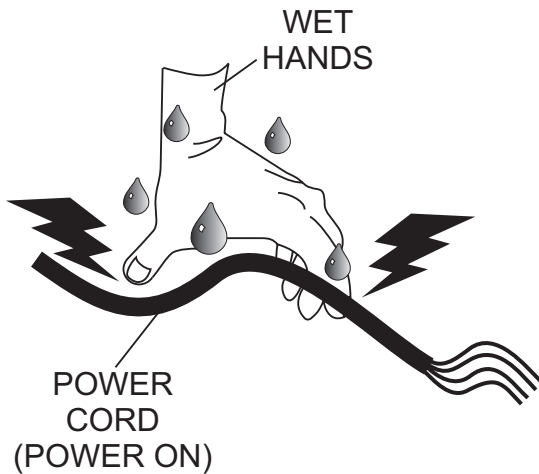

**Figure 18. Power Cord (Wet Hands)**

## **DANGER:**



**NEVER!** grab or touch a live power cord. **DO NOT** stand in water when connecting the pump's power cord into a voltage source. The possibility exist of electrical shock, electrocution and possibly **death!**

3. If all of the pump's electrical requirements have been met, insert the power plug on the pump into the power source receptacle.
4. Wait a few seconds and water should begin to flow from the discharge hose.
5. If water is not flowing from the discharge hose or not flowing freely after a few minutes, remove the power from the pump and check the system for leaks.

## **Pump Shut-Down/Clean-up**

1. Remove the power from the pump by turning off the circuit breaker or switch that provides power to the pump. Remember to make sure that hands are dry (not wet), and feet are not standing in water when removing disconnecting power from the pump.
2. Using the lifting rope, lift the pump up from its current position. Remove the discharge hose from the discharge port on the pump.
3. Remove all power cables and float switches from the control box. Place cables and float switches in a suitable container where they will not get damaged.
4. If the pump was used to pump mud, grit or silt, flush vigorously with clean water.
5. Remove the pump from the water. Wipe off any mud or debris that might have attached itself to the pump.
6. Store pump in a clean dry place away from dirt and debris.

# ST-3050D SUBMERSIBLE PUMP — MAINTENANCE

## LUBRICATION

To check the oil level of the mechanical seal perform the following:

1. Lay the pump (Figure 19) on its side with the oil plug facing upwards.
2. Remove oil fill plug.
3. Visually inspect oil plug hole to verify that oil cavity is full enough to cover seal spring. Check every 300 hours, change hydraulic oil every 6 months (1,000 hours) or as needed.
4. While checking the hydraulic oil level, also check the condition of the hydraulic oil in the seal cavity. Block the opening with a finger and roll pump to one side to drain oil into a small transparent container. If oil is cloudy or has water in it, drain oil from pump cavity and replace hydraulic oil. Check the seal for wear damage.

5. If oil level is low fill with SAE 10 weight non-detergent hydraulic oil (i.e. Shell Turbo 32 or equivalent). Fill oil cavity 75% to 85% full (allow air space for expansion). Pump oil cavity capacity is approximately 180 cc.

## IMPELLER

1. Make sure the clearance between the impeller and the friction disk is approximately .012 - .020 inches (.304 - .508 mm.)
2. If impeller is defective or badly worn, replace impeller immediately.

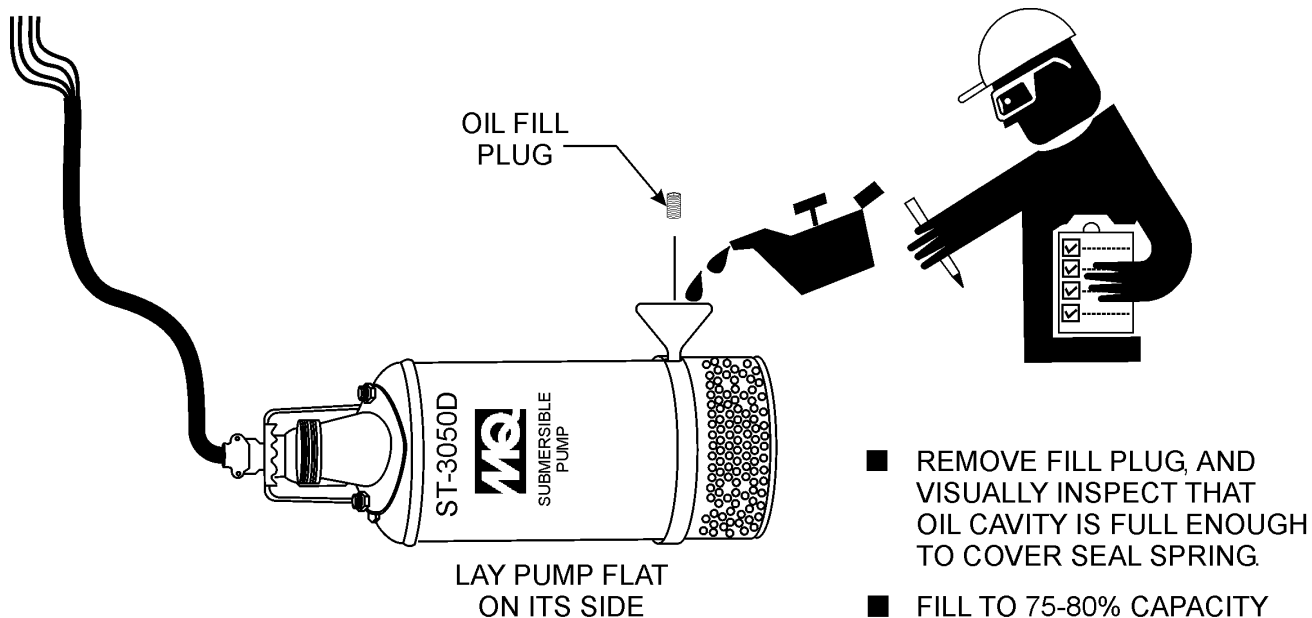

Figure 19. Checking Hydraulic Oil

- REMOVE FILL PLUG, AND VISUALLY INSPECT THAT OIL CAVITY IS FULL ENOUGH TO COVER SEAL SPRING.
- FILL TO 75-80% CAPACITY (APPROXIMATELY 180 CC.)
- FILL WITH 10 WEIGHT NON-DETERGENT HYDRAULIC OIL. USE SHELL TURBO 32 OR EQUIVALENT.
- CHECK HYDRAULIC OIL EVERY 300 HOURS. CHANGE EVERY 6 MONTHS OR AS NEEDED.

# ST-3050D SUBMERSIBLE PUMP — TROUBLESHOOTING

## TABLE X. PUMP TROUBLESHOOTING

SYMPTOM	POSSIBLE PROBLEM	SOLUTION
<b>Pump Fails To Start</b>	Incorrect voltage/amps?	Check that proper voltage (230/460 3Ø) is being supplied to the pump. Also check that there is an adequate amount of current (amps) to run the pump. Check power source circuit breaker.
	Check electrical connections?	If using float switches check wiring, inspect power cord.
	Blown power fuse?	Replace fuse, check cause of blown fuse.
	Impeller locked?	Disconnect power cord and check for clogging and improper impeller clearance. Unclog pump. Check overload protection device.
	Wet motor windings?	Use multimeter to check motor insulation. Insulation resistance must be approximately 15 megohms. If resistance is low, disassemble pump motor and bake windings to dry them.
	Defective motor and pump bearings?	Check for excessive bearing wear, if worn replace bearings. Replace motor if defective.
<b>Pump Fails to Deliver Full Output</b>	Twisted or restricted discharge hose?	Lay hose flat un-kinked. Remove clog from hose line.
	Clogged pump strainer?	Clean strainer.
	Low voltage?	Use a voltmeter to check voltage while pump is energized. Voltage must be within $\pm 10\%$ . Check power source (no load and load). If an extension cord is used, make sure it has adequate current-carrying capacity for the required length.
	Impeller worn?	Replace impeller.
<b>Water in Seal Oil</b>	Defective water seal?	Replace water seal.
	Loose Oil Fill Plug?	Tighten securely.

Performance Curve

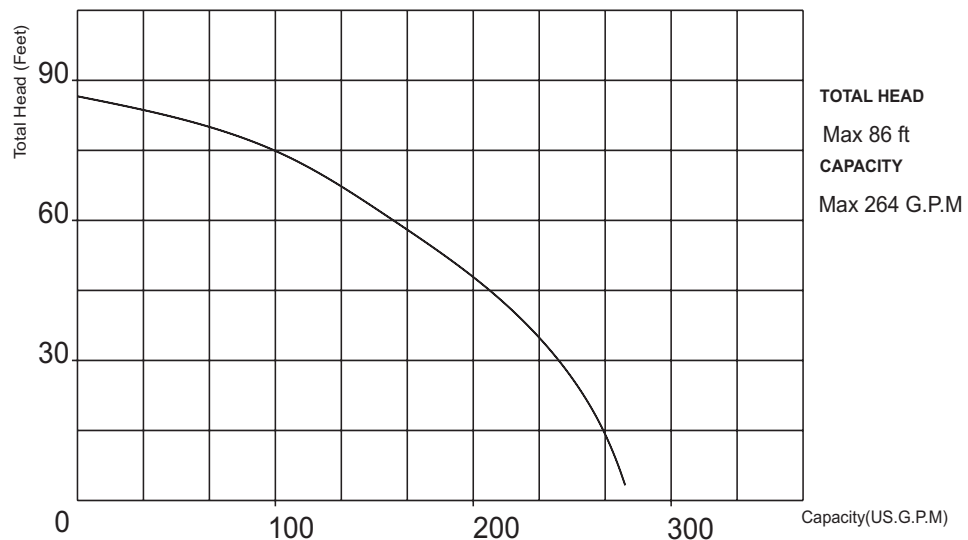

**Figure 20.**  
**Performance Chart**

# EXPLANATION OF CODE IN REMARKS COLUMN

How to read the marks and remarks used in this parts book.

## Items Found In the “Remarks” Column

Serial Numbers-Where indicated, this indicates a serial number range (inclusive) where a particular part is used.

Model Number-Where indicated, this shows that the corresponding part is utilized only with this specific model number or model number variant.

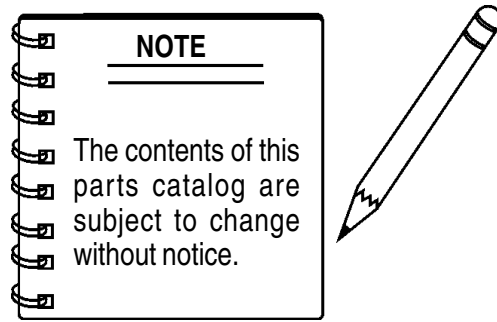

## Items Found In the “Items Number” Column

All parts with same symbol in the number column, \*, #, +, %, or ■, belong to the same assembly or kit.

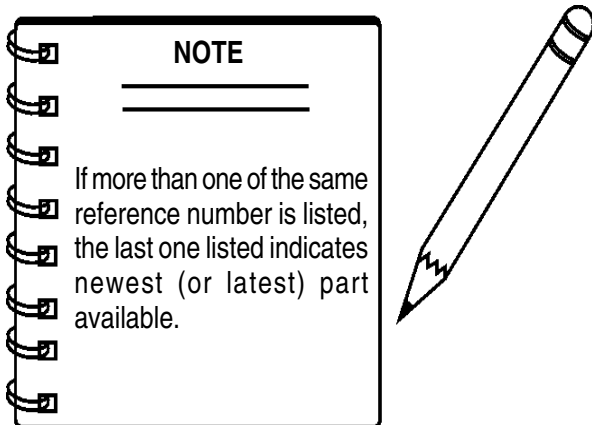

**ST-3050D SUBMERSIBLE PUMP 1 TO 3 UNITS**

***1 to 3 Units***

<b>Qty.....</b>	<b>P/N .....</b>	<b>Description</b>
1 .....	0203050120 .....	AC CORD W/CORD GLAND
1 .....	0203050060 .....	MECHANICAL SEAL
1 .....	0203050081 .....	OIL SEAL
1 .....	0203050047 .....	LINER
1 .....	0203050003 .....	IMPELLER
1 .....	0202020004 .....	IMPELLER NUT
2 .....	0203050214 .....	PACKING
1 .....	0202020157 .....	PACKING
1 .....	0202020435 .....	PACKING
1 .....	0202020435 .....	SPRING WASHER

# ST-3050D — ELECTRIC SUBMERSIBLE PUMP ASSY.

ELECTRIC SUBMERSIBLE PUMP ASSY.

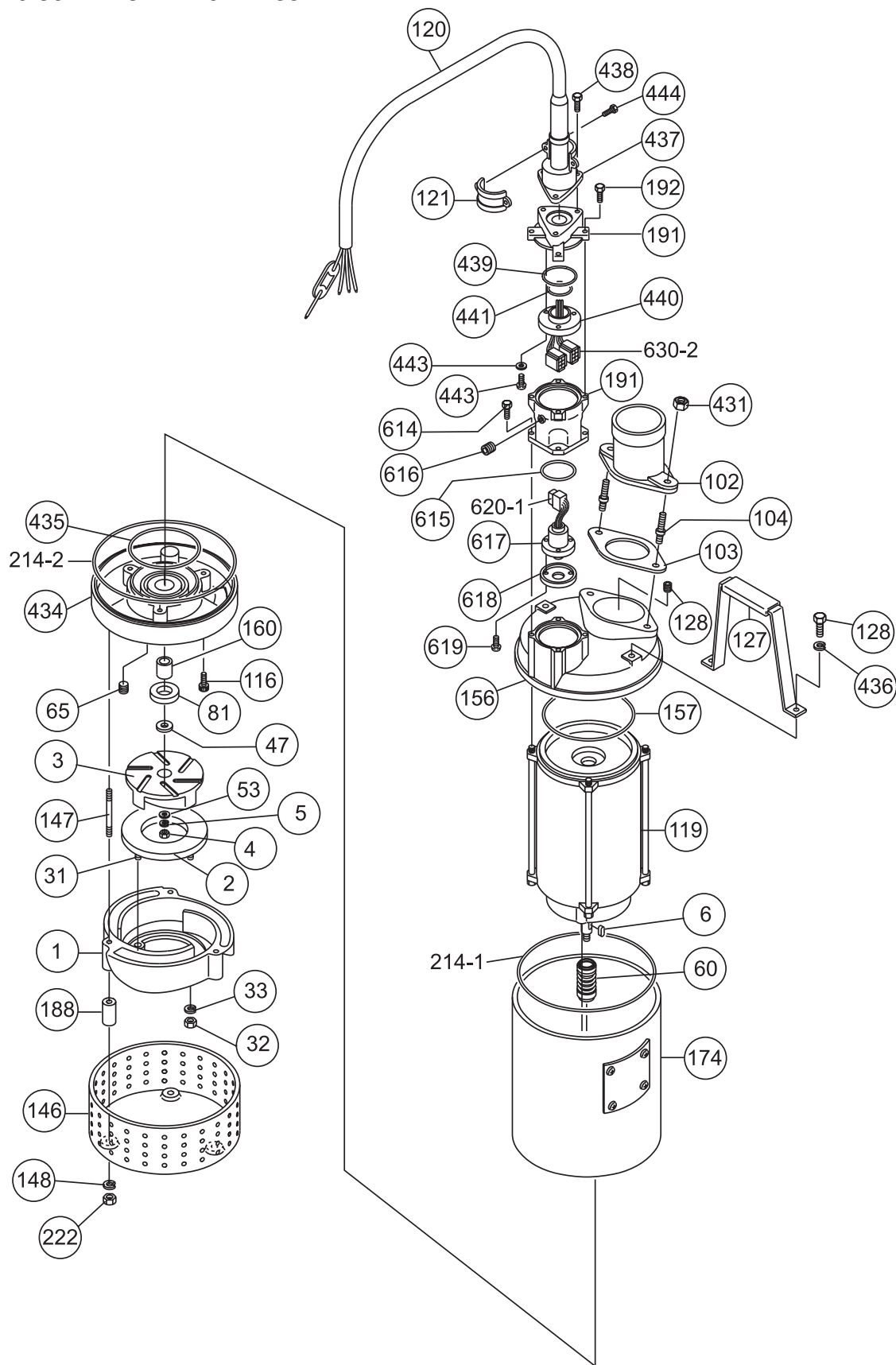

# ST-3050D — ELECTRIC SUBMERSIBLE PUMP ASSY.

## ELECTRIC SUBMERSIBLE PUMP ASSY.

<u>NO</u>	<u>PART NO</u>	<u>PART NAME</u>	<u>QTY.</u>	<u>REMARK</u>
1	0203050001	CASING	1	
2	0203050002	FRICTION DISC.	1	
3	0203050003	IMPELLER	1	
4	0202020004	IMPELLER NUT	1	
5	0202020005	SPRING WASHER	1	
6	0203050006	IMPELLER KEY	1	
31	0202020031	STUD BOLT	4	
32	0202020032	NUT	4	
33	0202020033	WASHER	4	
47	0203050047	LINER	1	
53	0202020053	WASHER	1	
60	0203050060	MECHANICAL SEAL	1	
65	0202020065	PLUG	1	
81	0203050081	OIL SEAL	1	
102	0203050102	DISCHARGE PORT	1	
103	0203050103	PACKING	1	
104	0203050104	STUD BOLT	2	
116	0202020116	BOLT	3	
119	0203050119	MOTOR .....	1	ST-3050
119	0203050D119	MOTOR .....	1	ST-3050D
120	0203050120	AC CORD W/CORD GLAND	1	
121	0202020121	CORD CLAMP	1	
127	0202020127	CARRYING HANDLE	1	
128	0202020128	BOLT	2	
146	0203050146	STRAINER	1	
147	0203050147	STUD BOLT	4	
148	0203050148	SPRING WASHER	4	
156	0203050156	HEAD COVER	1	
157	0202020157	PACKING	1	
160	0203050160	SLEEVE	1	
174	0203050174	OUTER PIPE	1	
188	0203050188	STRAINER SET PIPE	4	
191	0202020191	POWER CORD GLAND CASE	1	
192	0202020192	BOLT	4	
214-1	0203050214	PACKING	1	
214-2	0203050214	PACKING	1	

# ST-3050 D— ELECTRIC SUBMERSIBLE PUMP ASSY.

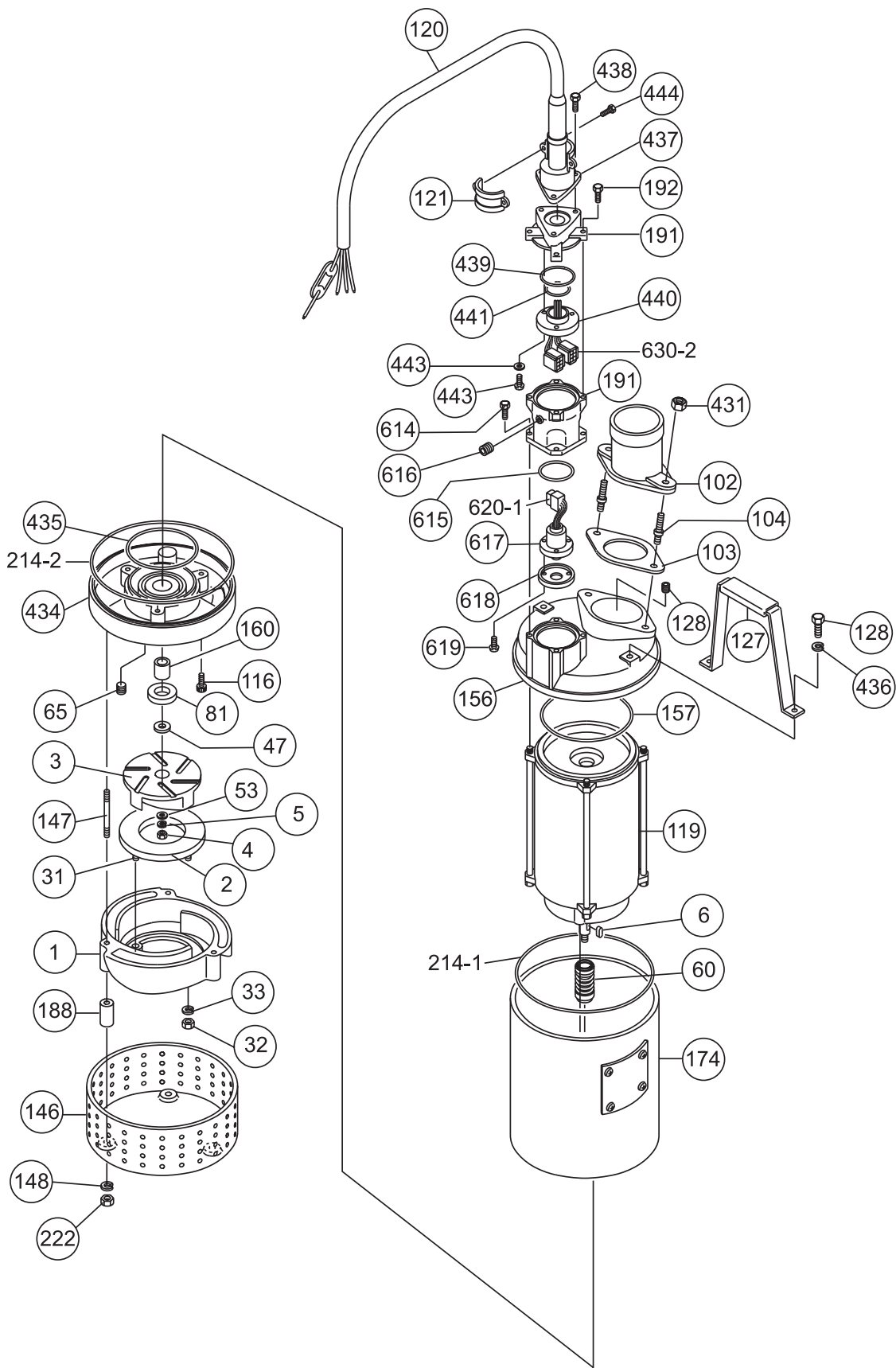



## ST-3050D — ELECTRIC SUBMERSIBLE PUMP ASSY.

### ELECTRIC SUBMERSIBLE PUMP ASSY.

<u>NO</u>	<u>PART NO</u>	<u>PART NAME</u>	<u>QTY.</u>	<u>REMARK</u>
222	0203050222	NUT	4	
224	0202020224	PLUG	1	
431	0203050431	NUT	2	
434	0203050434	STUFFING BOX	1	
435	0202020435	PACKING	1	
436	0202020436	SPRING WASHER	2	
437	0202020437	CORD GLAND CASE COVER	1	
438	0202020438	BOLT	3	
439	0202020439	PACKING	1	
440	0202020440	CONNECTOR	1	
441	0202020441	PACKING	1	
442	0202020442	BOLT	3	
443	0202020443	WASHER	3	
444	0202020444	BOLT	2	
613	0203050D613	CONNECTOR CASE	1	ST-3050D
614	0203050D614	BOLT	4	ST-3050D
615	0203050D615	PACKING	1	ST-3050D
616	0203050D616	PLUG	1	ST-3050D
617	0203050D617	GLAND RUBBER	1	ST-3050D
618	0203050D618	GLAND METAL	1	ST-3050D
619	0203050D619	BOLT	3	ST-3050D
620-1	0203050D620A	CONNECTOR	1	ST-3050D
620-2	0203050D620B	CONNECTOR	1	ST-3050D

# ST-3050D — ELECTRIC MOTOR ASSY.

ELECTRIC MOTOR ASSY.

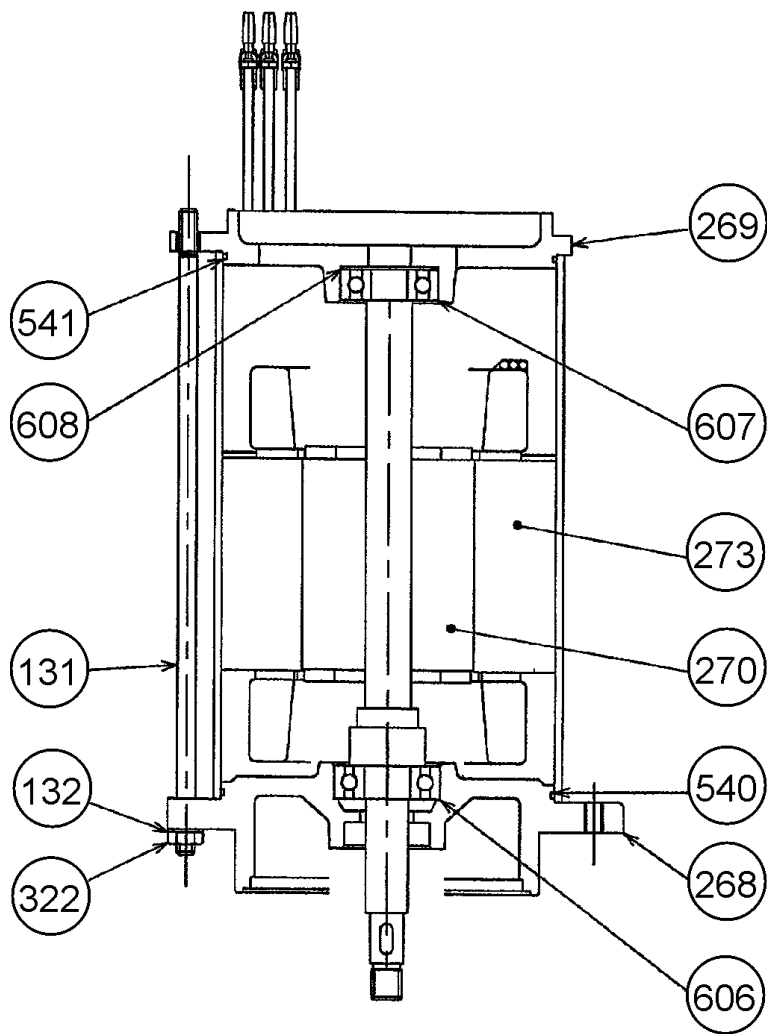

## ST-3050D — ELECTRIC MOTOR ASSY.

### ELECTRIC MOTOR ASSY.

<u>NO</u>	<u>PART NO</u>	<u>PART NAME</u>	<u>QTY.</u>	<u>REMARK</u>
131	0203050131	BOLT	4	
132	0202020B132	WASHER, LOCK	4	
268	0203050268	MOTOR A BRACKET	1	
269	0203050269	MOTOR B BRACKET	1	
270	0203050270	MOTOR ROTOR	1	
273	0203050D273	MOTOR STATOR	1	
322	0202020B322	NUT	4	
540	0203050540	A PACKING	1	
541	0203050541	B PACKING	1	
606	0203050606	A BEARING, MOTOR	1	
607	0203050607	B BEARING, MOTOR	1	
608	0202020B608	WASHER, WAVE	1	

**PAYMENT TERMS**

Terms of payment for parts are net 10 days.

**FREIGHT POLICY**

All parts orders will be shipped collect or prepaid with the charges added to the invoice. All shipments are F.O.B. point of origin. Multiquip's responsibility ceases when a signed manifest has been obtained from the carrier, and any claim for shortage or damage must be settled between the consignee and the carrier.

**MINIMUM ORDER**

The minimum charge for orders from Multiquip is \$15.00 net. Customers will be asked for instructions regarding handling of orders not meeting this requirement.

**RETURNED GOODS POLICY**

Return shipments will be accepted and credit will be allowed, subject to the following provisions:

1. A Returned Material Authorization must be approved by Multiquip prior to shipment.
2. To obtain a Return Material Authorization, a list must be provided to Multiquip Parts Sales that defines item numbers, quantities, and descriptions of the items to be returned.
  - a. The parts numbers and descriptions must match the current parts price list.
  - b. The list must be typed or computer generated.
  - c. The list must state the reason(s) for the return.
  - d. The list must reference the sales order(s) or invoice(s) under which the items were originally purchased.
  - e. The list must include the name and phone number of the person requesting the RMA.
3. A copy of the Return Material Authorization must accompany the return shipment.
4. Freight is at the sender's expense. All parts must be returned freight prepaid to Multiquip's designated receiving point.

5. Parts must be in new and resalable condition, in the original Multiquip package (if any), and with Multiquip part numbers clearly marked.
6. The following items are not returnable:
  - a. Obsolete parts. (If an item is in the price book and shows as being replaced by another item, it is obsolete.)
  - b. Any parts with a limited shelf life (such as gaskets, seals, "O" rings, and other rubber parts) that were purchased more than six months prior to the return date.
  - c. Any line item with an extended dealer net price of less than \$5.00.
  - d. Special order items.
  - e. Electrical components.
  - f. Paint, chemicals, and lubricants.
  - g. Decals and paper products.
  - h. Items purchased in kits.
7. The sender will be notified of any material received that is not acceptable.
8. Such material will be held for five working days from notification, pending instructions. If a reply is not received within five days, the material will be returned to the sender at his expense.
9. Credit on returned parts will be issued at dealer net price at time of the original purchase, less a 15% restocking charge.
10. In cases where an item is accepted, for which the original purchase document can not be determined, the price will be based on the list price that was effective twelve months prior to the RMA date.
11. Credit issued will be applied to future purchases only.

**PRICING AND REBATES**

Prices are subject to change without prior notice. Price changes are effective on a specific date and all orders received on or after that date will be billed at the revised price. Rebates for price declines and added charges for price increases will not be made for stock on hand at the time of any price change.

Multiquip reserves the right to quote and sell direct to Government agencies, and to Original Equipment Manufacturer accounts who use our products as integral parts of their own products.

**SPECIAL EXPEDITING SERVICE**

A \$35.00 surcharge will be added to the invoice for special handling including bus shipments, insured parcel post or in cases where Multiquip must personally deliver the parts to the carrier.

**LIMITATIONS OF SELLER'S LIABILITY**

Multiquip shall not be liable hereunder for damages in excess of the purchase price of the item with respect to which damages are claimed, and in no event shall Multiquip be liable for loss of profit or good will or for any other special, consequential or incidental damages.

**LIMITATION OF WARRANTIES**

No warranties, express or implied, are made in connection with the sale of parts or trade accessories nor as to any engine not manufactured by Multiquip. Such warranties made in connection with the sale of new, complete units are made exclusively by a statement of warranty packaged with such units, and Multiquip neither assumes nor authorizes any person to assume for it any other obligation or liability whatever in connection with the sale of its products. Apart from such written statement of warranty, there are no warranties, express, implied or statutory, which extend beyond the description of the products on the face hereof.



# PARTS AND OPERATION MANUAL

## **HERE'S HOW TO GET HELP**

*PLEASE HAVE THE MODEL AND SERIAL NUMBER  
ON-HAND WHEN CALLING*

### **PARTS DEPARTMENT**

*800/427-1244 or 310/537-3700*

*FAX: 800/672-7877 or 310/637-3284*

### **SERVICE DEPARTMENT**

*800/478-1244 or 310/537-3700*

*FAX: 310 - 537-4259*

### **WARRANTY DEPARTMENT**

*800/421-1244, EXT. 279 or 310/537-3700*

*FAX: 310 - 537-1173*

### **MAIN**

*800/421-1244 or 310/537-3700*

*FAX: 310 - 537-3927*



#### **MULTIQUIP INC.**

18910 WILMINGTON AVENUE  
CARSON, CALIFORNIA 90746  
310-537-3700

800/421-1244 NATIONWIDE  
FAX: 310 - 537-3927

#### **PARTS DEPARTMENT:**

800/427-1244  
FAX: 800/672-7877

#### **SERVICE DEPARTMENT:**

800/478-1244  
FAX: 310 - 537- 4259