

Terms & Conditions

Oneida Air Systems makes every effort to accurately represent our products and prices, however OAS reserves the right to make changes to products and prices at any time. As a manufacturer, OAS reserves the right to change product specifications at any time in an effort to achieve better quality products.

Fire Hazards and Codes

Warning! Explosion and fire hazard! Never vacuum flammable fluids or gas, oil, alcohol, solvents, etc. Do not operate near flammable fluids or gas. Never vacuum warm fluids or materials at more than 140 deg. F (60 deg. C), such as burning cigarettes, ashes, glowing coals, etc.
Warning! Do not vacuum hazardous / carcinogenic dust unless a HEPA filter is installed.
Always keep filter cartridge clean so the vacuum operates properly.
Empty Dust Deputy waste can frequently. Never leave flammable material in your Dust Deputy or shop vacuum.

Returned Goods Policy

Buyer must inform O.A.S. of any shortage or damage, by so noting in writing, on the freight delivery bill prior to signing to indicate receipt of shipment. All claims, including claims covered under the limited warranty, are subject to inspection and investigation by O.A.S. O.A.S. reserves the right to inspect, investigate all returned products before Buyer's claim is settled. All products returned for a cash refund must be unused, resaleable and purchased within 30 days. There are no refunds on flex hose, custom made components or partial kit items. Kits must be returned in full (all components) for credit. **There will be a 25% restocking fee applied to any returned items. Buyer must call and get an RMA (Return Authorization Number). Merchandise must be shipped to us prepaid.**

Limited Warranty

Oneida Air Systems™ warrants the products manufactured by Oneida Air Systems, for a period of 90 days or more depending on the product, to the original purchaser from the date of purchase unless otherwise specified. Purchaser is responsible for returning warranty items to OAS at their expense. All parts must be returned with an OAS provided Returned Material Authorization Number (RMA#). Any shipment without an RMA will be refused. Items not manufactured by Oneida Air Systems are limited to their own manufacturer's warranties. All electrical items such as magnetic starters, remotes, sensors, pumps and accessories are limited to 90 days. Oneida Air Systems warrants that the product will be free from defects in materials and workmanship. This warranty does not apply to defects due directly or indirectly to misuse, negligence, accidents, abuse, repairs, alterations, improper wiring or lack of maintenance. This is Oneida Air Systems sole written warranty and any and all warranties that may be implied by law, including any merchantability or fitness, for any particular purpose, are hereby limited to the duration of this written warranty. Oneida Air Systems does not warrant or represent that the merchandise complies with the provisions of any law or acts unless the manufacturer so warrants. In no event shall Oneida Air Systems' liability under this warranty exceed the purchase price paid for the product and any legal actions brought against Oneida Air Systems shall be tried in the State of New York, County of Onondaga.

ONEIDA AIR SYSTEMS SHALL IN NO EVENT BE LIABLE FOR DEATH, INJURIES TO PERSONS OR PROPERTY OR FOR INCIDENTAL, AND CONTINGENT, SPECIAL, OR CONSEQUENTIAL DAMAGES ARISING FROM THE USE OF OUR PRODUCT.

Before Purchasing or Installing a dust collection system the buyer is cautioned to do so in accordance with prescribed Federal, State, Local, OSHA, NFPA, and any other applicable codes or regulations relating to the type of dust(s) you are collecting.

SOME TYPES OF DUST UNDER CERTAIN CONDITIONS HAVE THE POTENTIAL TO BE EXPLOSIVE.

Oneida Air Systems is not responsible for how the dust collector is used or installed. Dusts with deflagration or explosion risks, such as wood dust, may require additional safety equipment including but not limited to; venting, spark detection, suppression systems, back draft dampers or may require installation in an outside location or in a protected area away from personnel. The customer assumes the responsibility for contacting their insurance underwriter with regard to specific engineering controls or application requirements. (We suggest you reference NFPA 664, 654 and 68 codes for more information) Oneida Air Dust Collection Systems may not be suitable for some applications and are not designed to be used in explosive atmospheres. **Oneida Air Systems equipment should only be installed and wired by a licensed electrician following all applicable local and national electrical codes.**



ZBM000036DIY / 1-2014



The Original

Dust Deputy®



AXD001004



AXD001004SD

D.I.Y Dust Deputy® Owner's Manual

U.S. Patent #7,282,074 C1

1.800.732.4065 www.oneida-air.com

System Start-Up Information

Safety Instructions to be Strictly Followed.

Read the installation and maintenance instructions as well as the recommended safety practices in this manual and your shop vacuum's owner's manual before assembling and using the Dust Deputy®.

- ▶ Do not vacuum anything that is burning or smoking, such as cigarettes, matches, or hot ashes.
- ▶ Do not vacuum, or use this Dust Deputy® near flammable or combustible liquids, gases, or explosive dusts, such as gasoline or other fuels, lighter fluid, cleaners, oil-based paints, natural gas, hydrogen, coal dust, magnesium dust, grain dust, aluminum dust, sugar dust, flour dust or gun powder.
- ▶ To reduce the risk of health hazards from vapors or dusts, do not vacuum toxic materials unless a HEPA filter is used. Do not use or store near hazardous materials.
- ▶ The Dust Deputy® is made from static dissipating plastic. Additional grounding is recommended for increased safety. See grounding instructions.
- ▶ Wood dust mixtures are highly flammable and can be explosive. **NEVER** introduce sparks or sources of ignition into collector.
 - 1.) Dump drum after each use.
 - 2.) Ground system. (See pg. 9) For added safety.
- ▶ **NEVER leave wood dust in a building or vehicle.**
- ▶ Keep fire extinguishers handy at all times.
- ▶ Can be used for collecting non-flammable liquids.
- ▶ **Always read your shop vacuum owner's manual for safety procedures regarding the operation of your shop vacuum.**
- ▶ Dispose of waste in a **FIRE SAFE AREA.**

WARNING / SAFETY

Some dusts are highly flammable or explosive. Learn / know what you are dealing with. Follow all local, state, federal & NFPA codes and guide lines.

Troubleshooting

- ▶ Dust Deputy® not separating well. (Only a tiny amount of dust should reach the vacuum.)
Air leak. Check cyclone flange / drum lid / barrel. Even small leaks will affect performance.
- ▶ Low air volume.
Vacuum filter clogged. Blockage in hose.
- ▶ Material swirls in cyclone and won't drop down into drum.
Air leak in bottom of cyclone / drum lid or dust drum.
Large, bulkier material might swirl. Restart or temporarily cut off air flow to drop material down.
- ▶ Hose connections not tight.
Due to the varied hose diameters, flexible couplers can be used. They are available at local hardware stores in the plumbing section.



To Prevent Hose Pull Off

The inlet and outlet of the Dust Deputy® are shouldered and tapered to adapt to a range of vac hose sizes. If on your model the friction fit isn't as tight as needed you can do the following:

- ▶ Use a hose clamp.
- ▶ Wrap the inlet and outlet of the Dust Deputy with a layer of electrical tape to increase the friction fit.
- ▶ Secure with a sheet metal screw.

For additional static reduction in the clear cyclone only, install metal tape as shown.



Cover bolt hole and use the bolt for the grounding wire anchor.

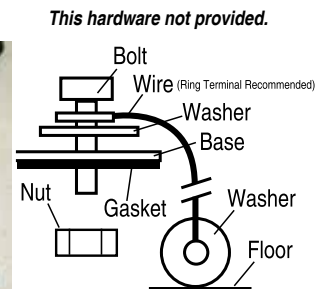

For added grounding, attach wire to bolt between bolt head and washer, then attach another washer to end of wire. Wire must be long enough for washer to lie flat on floor.

Adding Cyclones to Improve Performance

Top View



This arrangement may be useful for very fine dust situations.

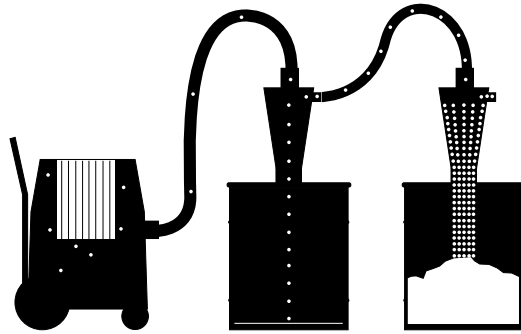

Attach in Series

Increases particle efficiency.

Top View

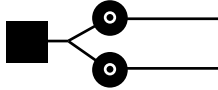

Your arrangement is only limited by your imagination!

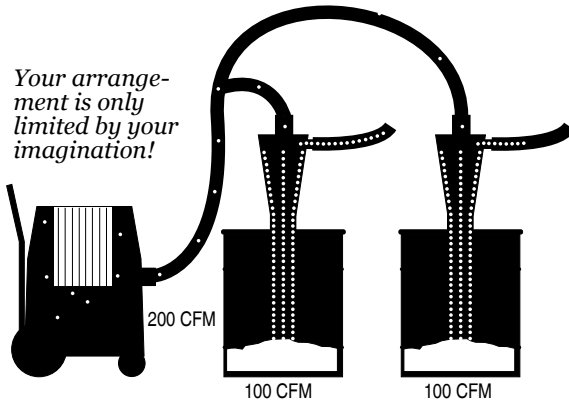

Attach in Parallel

Same particle efficiency but increases CFM.

Top View

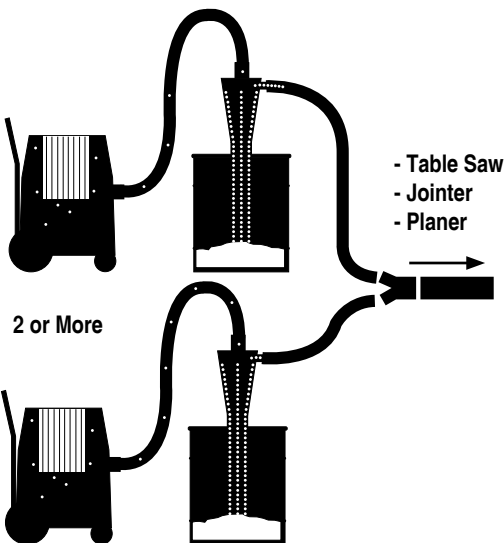
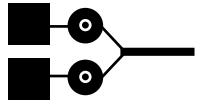

Multiple Vacuums

More Airflow to Big Tools.
More CFM.

D.I.Y. Kit Contents

Plastic D.I.Y. Dust Deputy® - AXD001004

OR

Plastic D.I.Y. SD Dust Deputy® - AXD001004SD

U.S. Patent #7,282,074 C1

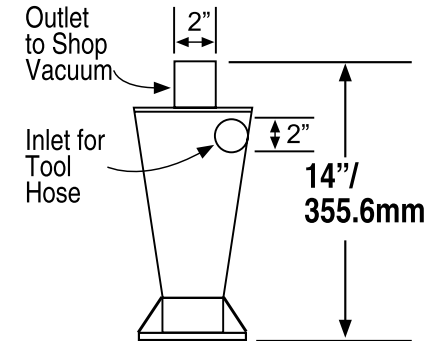

D.I.Y. Cyclone

With the D.I.Y. Dust Deputy, you only receive the plastic cyclone. You must supply all hardware and buckets yourself.

Remember that the larger the container, the sturdier the walls must be to prevent collapse.

The difference between the black Dust Deputy and the clear Dust Deputy is that the black cyclone is more static dissipative and does not need any additional static reduction tape for use. Measurements and DIY applications will be the same.

Regardless of where you purchased your Dust Deputy®, if you have any questions or issues with missing parts, damage or replacement issues, please call Oneida Air Systems *first* to let us help to resolve your problem! We fully stand behind our product and value our customers and want to do everything possible to make your purchase and experience with Oneida Air Systems a good one!

For Customer Service

M - F 8:30 - 5:00 pm EST

866 - 387 - 8822

customerservice@oneida-air.com

Assembly Instructions for D.I.Y. Dust Deputy®

The Dust Deputy is made of static dissipating plastic*.

These are the minimum parts you will need to acquire to use the Dust Deputy:

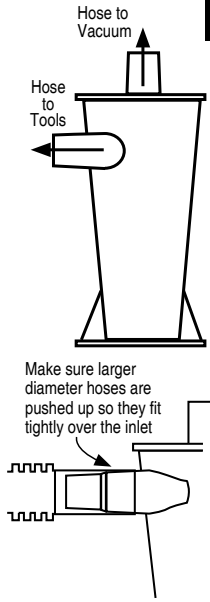

- Shop Vacuum
- Dust drum or container that will withstand the vacuum pressure (We recommend at least a 90 mil side thickness otherwise the container may collapse when in use.) and has a lid that can be tightly sealed. (e.g.- 5 gal. plastic drywall bucket) Drum must be 100% air tight.
Any air leak in lid or drum will affect separation performance. For wood dust, use of a smaller container is better (up to 10 gal.) The larger the container, the sturdier the walls must be to prevent collapse. To reduce the chance of fire hazard, empty container after each use.
- 2" - 2 1/4" dia. Vacuum Hose to go between the Dust Deputy outlet and your Shop Vacuum.
- Vacuum Hose to attach to Dust Deputy inlet and your tools.
- (6) 1/4" x 1" bolts with nuts and washers.
- Any suitable sealant (e.g.- Silicone) to use between the cyclone base flange and the top of your dust container. Any air leak between the cyclone and lid will affect separation performance. You should also seal the inlet and outlet hose connections.

* - For added safety the D.I.Y. Dust Deputy can be grounded with copper wire. See Pg. 6

How to Make Template for Drum Lid and Assemble Dust Deputy®

1. Place cyclone base in center of drum lid.
2. With pen, trace around base and bolt holes.
3. Connect opposite bolt holes with lines as shown above to find center.
4. Draw 3" dia. circle for drum inlet. Carefully cut out 3" hole in lid.
5. Use 5/16" drill bit to drill bolt holes.
6. Spread even layer of sealant between center hole and bolt holes on drum lid. (See above diagram.) **You must have a complete seal between cyclone and drum lid or performance will be affected.**
7. Put bolts through washer and cyclone base then fasten with nuts under drum lid.
8. Lid must completely seal to drum. Gasket must be used. **Any air leaks will affect performance.**
9. Attach one hose from top cyclone outlet to shop vacuum and the other hose from side cyclone inlet to your tools or use hose by itself to pick up waste.

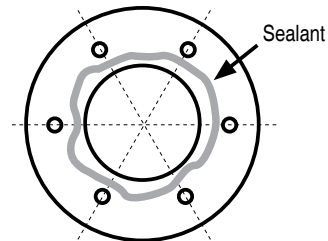

Additional Ideas for the D.I.Y. Dust Deputy®

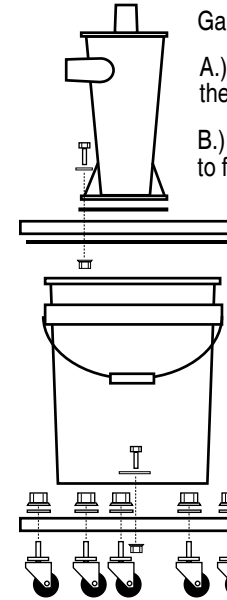

Gasket can be glued to bottom of bucket lid.

- A.) An example of a plywood top that had a groove routed out of it to fit the bucket rim and accommodate the gasket.
- B.) For mobility and additional stability, you can make a plywood platform to fasten your bucket to. We recommend 5 casters for the best stability.



You are only limited by your imagination and if you can seal your top and if your container can stand up to your suction pressure without collapsing.

No casters are included in D.I.Y kit.



Other examples of ways the D.I.Y. can be used.

The Multi-Cyclone DIY Dust Deputy® Kit gives you twice the suction of a single vacuum for bench top tools, or any other kind of cleanup your shop, worksite, or home requires. This is a one-of-a-kind, build it yourself dust collection system!

Go to our website to see the instructions for how to build this system.

Additional parts and assembly required. Not sold as shown.

