



BN Products - USA, LLC.

A Division of Benner-Nawman, Inc. - Wickenburg, AZ

PRODUCT: BNG5500iE

Inverter/ Generator

OPERATIONS MANUAL



REV | 04112022

BNG5500iE Owners Manual 04112022.indd



BN PRODUCTS_USA, LLC.
3450 Sabin Brown Road • Wickenburg, AZ 85390
(800) 992-3833 • mail@bnproducts.com

Thank you

Thank you for choosing our BNG5500iE Inverter Generator.

This manual covers the proper operation and maintenance.

Before operating, please read this manual carefully for essential procedures and safety.

All technical data and drawings in this manual are consistent with the information on this product. However, as a result of revisions and other ongoing updates, the contents of this manual may be slightly different from the actual product. Please understand that BN Products reserves the right to make changes without notice and without incurring any obligation.

The copyright of this instruction manual belongs to us. No reproduction is allowed without written consent from BN Products-USA. All rights are reserved.

This manual is a permanent part of this generator set. Please keep it in a safe location.



SAFETY MESSAGES

Your safety and the safety of others are very important. Therefore, we have provided important safety messages in this manual and on the generator.

Please read these messages carefully. A safety message alerts you to potential hazards that could hurt you or others. A warning symbol precedes each safety message.



You can be killed or seriously injured if you don't follow instructions.

SAFETY NOTICE

Read and understand this owner's manual before operating your generator. You can help prevent accidents by being familiar with your generator's controls and observing safe operating procedures.

- DO NOT operate indoors.
- DO NOT operate in wet conditions.
- DO NOT directly connect to the household power supply.
- DO NOT smoke when refueling.
- DO NOT overfill the fuel tank when refueling
- STOP THE ENGINE before refueling or servicing.
- PLEASE keep it away from any other flammable materials

SPECIAL REQUIREMENTS

- Electrical equipment, including lines and plug connections, must be properly insulated.
- The circuit breakers should be matched with the generator equipment.
- If the circuit breakers require replacement, they must be replaced with a circuit breaker with identical ratings and performance characteristics.
- Don't operate the generator before grounding.



COMPONENT IDENTIFICATION

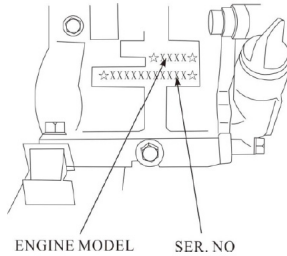
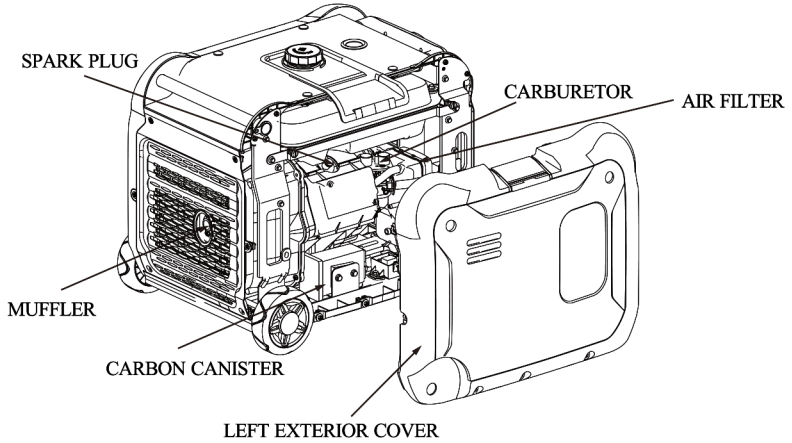
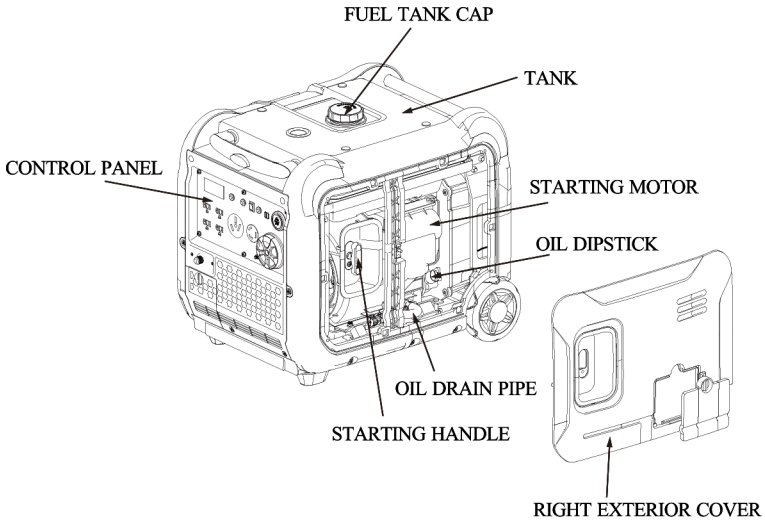

CONTROL FUNCTIONS

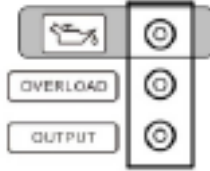

Oil Warning Light (Red)

When the oil level falls below the minimum requirements, the oil warning light comes on and the engine will stop automatically. Unless you refill with oil, the engine will not start again.

Tip: If the engine stalls or does not start, turn the engine switch to “ON” and then pull the recoil starter.

If the oil warning light flickers for a few seconds, the engine oil is too low to protect the engine.

Add oil and restart.



Overload indicator light (Red)

The overload indicator light comes on when an overload of a connected electrical device is detected, the inverter control unit overheats, or the AC output voltage rises. Then, the AC protector will trip, stopping power generation to protect the generator and any connected electric devices. The AC pilot light (Green) will go off, and the overload indicator light (Red) will stay on, but the engine will not stop running.

When the overload indicator light comes on, and power generation stops, proceed as follows:

- Turn off any connected electric devices and stop the engine.
- Reduce the total wattage of connected electric appliances within the rated output.

- Check for blockages in the cooling air inlet and around the control unit.
- If any blockages are found, remove them.
- After checking, restart the engine

Tip: The overload indicator light may come on for a few seconds when using electric devices that require a large starting current, such as a compressor or a submersible pump. This is normal and not a malfunction.

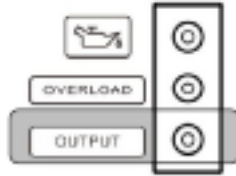

AC Pilot Light (Green)

The AC pilot light comes on when the engine starts and produces power.

Engine Smart Control (ECO)



“ON”

When the ECO switch is turned to “ON,” this feature controls the engine speed according to the connected load. The results are better fuel consumption and less noise.

“OFF”

When the ECO switch is turned “OFF,” the engine runs at the rated/min (3600r/min) regardless of whether it is connected to a load.

Tip: The ECO must be turned to “OFF” when using electric devices that require a large starting current, such as a compressor or a submersible pump.

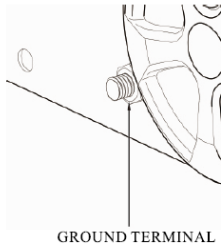

Ground (Earth) Terminal

The ground terminal should be connected to the appropriate ground to prevent electric shock. Consult a qualified electrician for proper instruction.

PREPARATION

Fuel

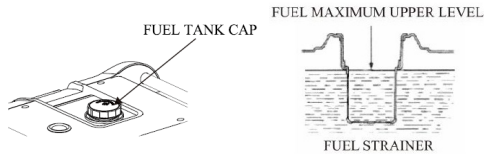

Fuel is highly flammable and poisonous. Check “SAFETY INFORMATION” carefully before filling.

- Do not overfill the fuel tank; Thermal expansion can cause the fuel to overflow and leak from the cap or vent.
- After filling the fuel, ensure the fuel tank cap is tightened securely.
- Immediately wipe off spilled fuel with a clean, dry cloth since fuel may deteriorate painted surfaces or plastic parts.
- Use unleaded gasoline only, as leaded gasoline can severely damage internal parts of the generator.
- Remove the fuel tank cap and fill the tank to the red level.
- Recommended fuel: Unleaded gasoline
- Fuel tank capacity: 3.5 Gallons

Engine Oil

Because of transportation regulations, this generator has been shipped without engine oil. Therefore, please do not start the engine until it is filled properly with sufficient 10W-30 engine oil.

Engine Oil Capacity: 0.84 Quarts

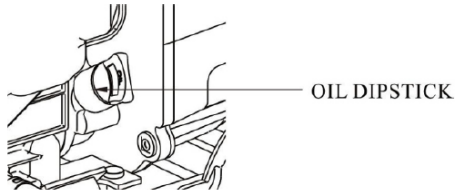

Recoil Starter

Pull the starter grip lightly until resistance is felt to start the engine, then pull briskly. Do not allow the starter to snap back against the machine. Instead, return it gently to prevent damage to the starter or other mechanisms.

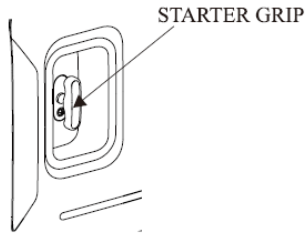

Fuel Valve

The fuel valve controls the fuel flowing from the fuel tank to the carburetor. Be sure to return the lever to “OFF” after stopping the engine.

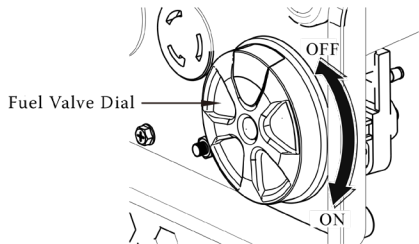

AC Circuit Breaker/Over Current Protector

The overload current will automatically switch off the circuit breaker to avoid a short circuit overload.



The over-current protector is in the “OFF” position when the protector switch is raised. Press the button of the AC over-current protector to the “ON” position to reset the protector. If the circuit breaker is switched OFF automatically, switch the circuit breaker ON again.

GENERATOR OPERATION

Generator Operation Environment:

- Temperature: -41°F ~104°F
- Humidity: Below 95%
- Height above sea level: 3000ft or lower (If the area is above 3000ft, the power output will be slightly lower).

NOTICE

It is not recommended to connect this generator to your building’s electrical power. This can potentially back feed electricity to the utility lines, putting utility workers’ lives at risk while performing repairs. Instead, if you need a backup generator or “whole house” standby power, please consult a qualified electrician to help you determine the best solution for your needs.







It is acceptable to run individual appliances only if they are directly plugged into the generator and are within the generator’s rated capacity. Do not run a generator inside your home for any reason. Make sure it is outside in a well-ventilated area

AC Current

Before starting the generator, make sure the total load appliance power (the total resistance, capacitive and inductive) does not exceed the generator’s rated capacity.

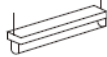
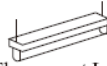
NOTICE

Overloading this generator will significantly shorten the generator service life. If the generator is connected to multi-loads or several electric appliances, please connect the largest load first, then the second-largest load, followed by the lightest load.

Type	Wattage		Typical Device	Examples		
	Start	Rated		Device	Starting	Rated
Incandescent Lamp Heating Device	X1	X1	 Incandescent Lamp  Tv Set	 Incandescent Lamp 100W	100VA (W)	100VA (W)
Fluorescent Lamp	X2	X1.5	 Fluorescent Lamp	 Fluorescent Lamp 40W	80VA (W)	60VA (W)
Motor Drive Device	X3-5	X2	 Refrigerator  Electric Fan	 Refrigerator 150W	450-750VA (W)	300VA (W)

The DC terminals provide a power supply for DC power loads and charge other batteries. The terminals are colored red to identify the positive (+) terminal and black to identify the negative (-) terminal. Load connection method: The load must be connected to DC terminals with the proper polarity (load positive to positive of DC terminal and load negative to negative of DC terminal).

High Altitude Operation

At high altitudes, a standard carburetor calibration will make the air-fuel mixture too rich. This will reduce the output power and increase fuel consumption. In addition, a rich mixture can foul the spark plug and cause hard starting of the engine. Extended operation at an altitude that differs from the engine's calibration can also increase emissions. A carburetor modification can improve high-altitude performance.

If you always operate the generator at high altitudes above 3300ft (1000m) from sea level, you can take it to one of our authorized dealers to make that adjustment. Even with the carburetor modification, engine horsepower will be reduced, thus lowering the output rating of the generator. Every 1,000 ft (300m) rise in altitude reduces the engine's power by about 3.5%. This decline is even more significant if the carburetor has not been appropriately adjusted.



Please note: If the carburetor has been modified for high-altitude operation, the air-fuel mixture will be too lean for low altitude use. This can cause overheating and damage to the engine while being used at low altitudes. Return the unit to your dealer to adjust the engine for low-altitude use.

STARTING THE ENGINE

Recoil Starter

- Unplug all appliances from the generator.
- Turn the fuel valve to the full “ON” position. This activates the choke
- If the unit is already warm, turn the fuel valve to the mid “ON” position
- Turn the generator switch to the “ON” position.
- Pull the starter grip until compression is felt, then pull briskly.
- Turn the fuel valve to the mid “ON” position after the engine is warm.

Electric starting

- Unplug all appliances from the generator.
- Turn the fuel valve to the full “ON” position. This activates the choke
- Turn the fuel valve to the mid “ON” position if the unit is already warm.
- Press the start button.
- After starting the engine, immediately release the start switch.
- Turn the fuel valve to the mid “ON” position after the engine is warm.
- If the starter is sluggish or fails to start the generator, the battery may require charging. Starting the generator with the pull cord and allowing it to run will charge the battery.

Electric Start with Remote

- Hold down the start button for 3 seconds to start the generator.
- Hold down the stop button for 3 seconds to shut the generator down.

Programming a new remote.

- Press and hold the “match” button on the generator’s front panel.
- While holding the “match” button, press and hold the start button on the remote until the engine light flashes three times.
- Let go of both buttons and start the generator by holding the start button.

Stopping the Engine

- Turn the AC circuit breaker to the “OFF” position.
- Turn the generator switch to the “OFF” position.
- Turn the fuel valve to the “OFF” position.



**To stop the engine in an emergency,
turn the generator switch to the “OFF” position.**

MAINTENANCE

Proper maintenance is essential for safe, economical, and trouble-free operation. The following pages are a guide to proper maintenance procedures and maintenance schedules using basic hand tools. Other service procedures are best handled by professionals and are typically performed by a factory-authorized repair facility.

The listed maintenance schedule applies to normal operating conditions. However, if you use your generator in excessively hot or dirty environments, consult your service facility for recommendations for your individual needs.

MAINTENANCE / PERIOD		EACH USE	1 MONTH OR 25 HOURS	3 MONTHS OR 50 HOURS	EVERY YEAR
ENGINE OIL	CHECK/REFILL	X			
	REPLACE		X	X	
AIR FILTER	CHECK	X			
ELEMENT	CLEAN		X		
PRECIPITATION CUP	CLEAN				X
SPARK PLUG	CHECK/ADJUST				X
SPARK ARRESTOR	CLEAN		X	X	
IDLE**	CHECK/ADJUST				X
FUEL TANK AND FILTER**	CLEAN				X
FUEL LINE	CHECK	EVERY 2 YEARS. REPLACE IF NECESSARY			
CYLINDER HEAD	REMOVE CARBON**	DISPLACEMENT 225cc			
** THESE ITEMS REQUIRE ADVANCED KNOWLEDGE TO PERFORM AND SHOULD BE SERVICED BY THE FACTORY.					

- Reduce the maintenance interval in extreme environments like excessively hot or dusty conditions.
- Replace engine oil every 10 hours.
- Clean air filter every 10 hours

- Replace the air filter every 25 hours.
- If you have missed the scheduled time to maintain your engine, do it as soon as possible.

NOTICE

A spot inspection should be performed before starting your generator. If the maintenance cycle time has passed, the maintenance should be carried out as soon as possible, according to the maintenance table.

WARNING

Stop the engine before servicing and put the generator on a level surface. Never run your machine in a poorly ventilated room or any other enclosed area, be sure to keep good ventilation in the working environment. The exhaust from the engine contains poisonous CO², and inhalation can cause shock, unconsciousness, and even death.

Engine Oil Change

Drain the oil while the engine is warm to assure complete and rapid draining.

Engine Oil capacity: 0.8 Qtr

- Ensure the fuel shut-off switch is in the “off” position to prevent fuel leakage.
- Place a suitable container next to the engine to catch the oil as it’s draining.
- Remove the oil drain bolt and let the oil run into the container. It may be necessary to tip the generator slightly to ensure all the oil has drained.
- Reinstall the oil drain bolt, and with the engine in a level position, refill the engine oil to the proper level.
- Wash your hands with soap and water after handling used oil.
- SAE oil viscosities are on the API label of the oil container. Therefore, we recommend using API service category SJ or later (or equivalent) oil.
- SAE 10W-30 is recommended for general use.

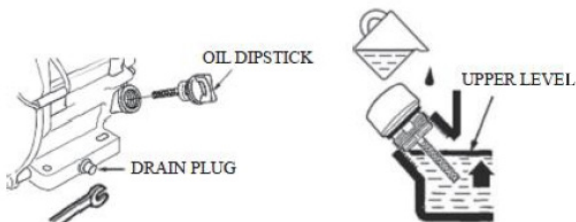



Please dispose of used engine oil in a manner that is compatible with the environment. Do not throw it in the trash or pour it on the ground. Please recycle your used oil properly. Need help finding somewhere to recycle your oil? Earth911.com is a network that connects you to local environmental programs in the United States and parts of Canada. Visit Earth 911 or call 1-800-CLEAN-UP for more information and to find a location near you.

Air Filter Maintenance

A dirty air filter will affect the flow of air into the carburetor. This can lead to excessive fuel use and high emissions levels and even prevent the generator from starting. Therefore, air filters should be regularly maintained. If used in a dusty environment, it should be maintained more frequently.

Cleaning the filter element with gasoline or flammable solvents may cause fire or explosion. Clean with soap and water only. Let dry thoroughly before installing the filter.

Running the generator without an air filter or running with a damaged filter will cause internal damage to the engine. Running the generator in this condition will not be covered by the unit's warranty.



- Open the air filter cover latch and remove the air filter element. Check the filter element for any tears, holes, or other damage. Replace if damaged.
- If the foam filter element is dirty, clean it by washing it in warm soapy water. Be sure to rinse the filter element thoroughly.
- Allow the filter element to dry completely.
- Once the filter is dry, add a few drops of clean engine oil and squeeze the filter, so the oil soaks the entire filter. Do not twist the filter element as that can cause damage. Also, do not apply too much oil as this can cause the generator to smoke once started.
- Clean any debris from the filter housing with a damp cloth. Do not allow any dirt or debris to enter the opening leading to the carburetor.
- Install the filter element and replace the air filter cover.

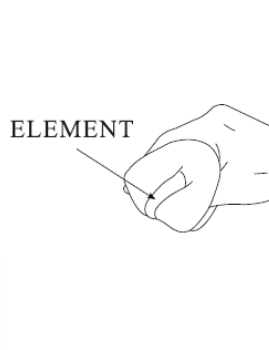
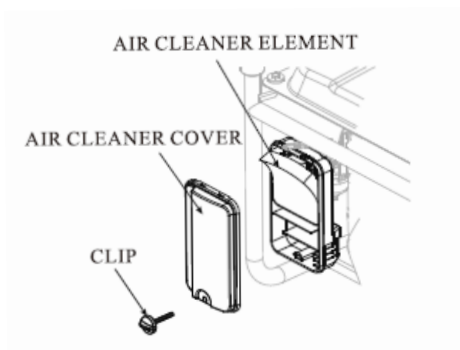

Fuel Sediment Cup Cleaning

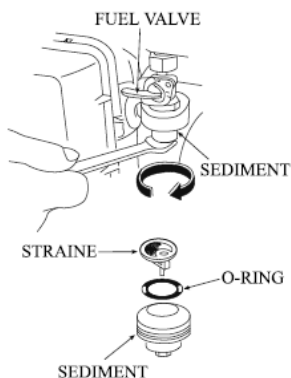

- Turn the fuel valve to the OFF position.
- Remove the sediment cup, O-ring, and strainer according to the arrow direction.
- Clean the sediment cup, O-ring, and strainer in nonflammable or high flash point solvent.
- Reinstall O-ring and strainer and screw down the sediment cup.
- Turn the fuel valve ON and check for leaks.

Spark Plug Service

Replace the spark plug with the original type: 7RTC

- Remove the spark plug wire.
- Clean any dirt or debris that might have collected around the spark plug before removing the spark plug
- Use a spark plug socket wrench to remove the spark plug. (Available commercially)
- Visually inspect the spark plug insulator and contacts for damage or wear. Replace the spark plug if necessary.
- Measure the spark plug gap with a thickness gauge. Bend the electrode to adjust the clearance. The clearance should be between .028-.030 in. (0.7 – 0.8) mm.

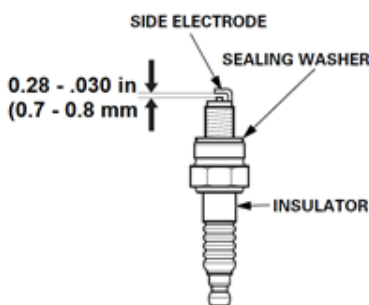

- Check that the spark plug sealing washer is in good condition.
- Install the spark plug and tighten it with the spark plug socket wrench.
- Reinstall the plug wire on the spark plug. Make sure to push it down firmly.

>>> **Use only recommended spark plugs** <<<

Spark Arrester Cleaning



The spark arrester must be serviced every 50 hours to function as designed.

If the engine has been running, the muffler will be too hot to repair. Let the muffler cool completely before servicing the spark arrester.

Cleaning procedure

- Locate the two screws at the rear of the muffler that holds the spark arrester in the muffler.
- Remove screws and spark arrester screen
- Lightly brush the screen with a wire brush to remove carbon deposits.
- Take care not to damage the screen. If the screen is torn or damaged, it must be replaced.
- Install the spark arrester in the reverse order

STORAGE



Following proper storage preparation procedures will help keep your generator trouble-free. Reference the steps listed below before storing your generator.

Cleaning before storage

Wipe the generator with a damp cloth to clean any dirt or debris that may have been collected. Then, allow it to air dry.

Draining the gas tank

Gasoline will oxidize and deteriorate in storage. In addition, old gasoline will cause hard starting and can leave deposits that will clog the carburetor, fuel tank, and fuel lines. If this happens in your generator, you may need to have the fuel system components serviced or replaced.

The length of time you can leave gasoline in your generator depends on several factors. Gasoline blend, storage temperature, and even how much fuel is in the tank can accelerate deterioration. For example, warm storage will accelerate gasoline deterioration to just a few months. Less if the gasoline was not fresh when you filled the tank.



Gasoline is highly flammable. You can be burned or seriously injured when handling fuel.

- Stop the engine and let it cool completely.
- Keep all heat, sparks, and flame away.
- Only drain fuel outdoors in a well-ventilated area.
- Wipe up spills immediately.
- Unscrew the fuel filler cap, remove the fuel filter and empty the tank into a suitable container. We recommend a hand pump suitable for gasoline. Do not use an electric pump.
- Clean the fuel filter and precipitation cup. Next, unscrew the carburetor drain bolt, drain the fuel from the carburetor entirely, then reinstall and tighten the carburetor drain bolt.

STORAGE TIME	RECOMMENDED FUEL STORAGE PROCEDURES
Less than one month	No preparation required
1 to 2 months	Fill with fresh gasoline and add a stabilizer to the fuel. *
Two months to 1 year	Drain fuel system and follow storage procedures.
One year or more	Drain fuel system and follow storage procedures. Change engine oil and lubricate the cylinder.

*Use a stabilizer that is formulated for extended storage life.

Draining The Oil

It is recommended to change the oil before storing the generator long-term.

Prepare Engine For Storage.

- Make sure the fuel switch is in the “off” position.
- Remove the spark plug. Pour approximately one teaspoon of clean engine oil into the combustion chamber. Pull the start handle several times to distribute the oil. Reinstall the spark plug.
- Gently pull the starting handle until resistance is felt. Then return the starting handle gently. This will leave the intake and exhaust valves closed to help keep moisture out of the combustion chamber.
- Store the generator in a clean and dry area.

Storage Precautions

- Storing your generator with fuel in the tank can pose a risk of gasoline vapor ignition. It is important to reduce that risk by only storing the generator in a well-ventilated area. Do not store next to any sources of ignition. Such as a furnace or water heater.
- Avoid areas with high humidity. This can cause excessive rust that is damaging to the generator.
- Place the generator on a level surface. Tilting or laying it on its side can cause fuel or oil leakage.
- Be sure the fuel switch is in the “off” position.

Removal From Storage.

- Use the instructions outlined in the startup section of this manual
- If fuel was drained for storage, fill the tank with fresh gasoline.
- If the combustion chamber was coated with oil during storage, the engine might smoke briefly at startup. This is normal and should clear up within a few seconds.

	Item	BNG5500iE
Engine	Gasoline Engine Type	Single Cylinder, 4-stroke,- Forced Air Cooling, OHV
	Displacement	312 cc
	Igniting System	CDI
	Oil Capacity	0.8 Qt
Generator	Fuel Volume	13.5 Gal
	Rated Frequency	50/60 Hz
	Rated Voltage	230/120/240 V
	Rated Output Power	5 kW
	Maximum Output power	5.5 kW
	DC	12/8.3 V/A
Gen Set	Length (mm)	24" (610)
	Width (mm)	18.5" (470)
	Height (mm)	21" (535)

TROUBLESHOOTING

Engine not to start:

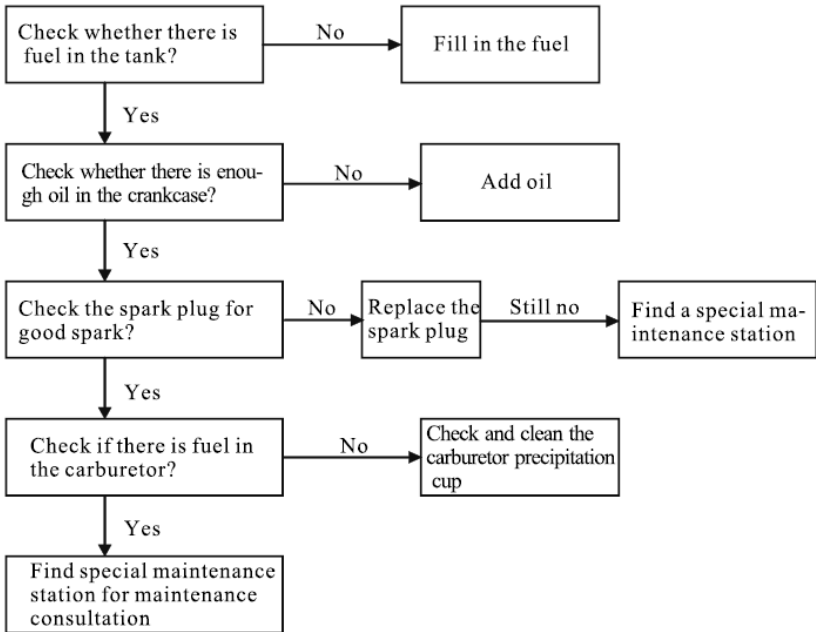

There is no voltage :

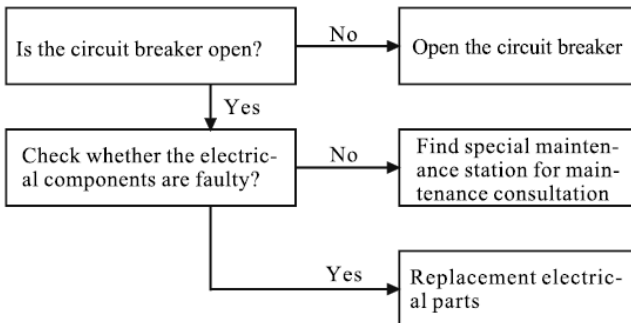

ELECTRICAL SCHEMATIC

